

















INSTALLATION MANUAL

11106PF

ecolight |        |     

350mA | 6W | IP20 | Fire rated | Die cast | Requires 350mA driver. | **80 CRI** |  75mm |  90mm |  40cm

 89mm
 70mm
Dimensions are complete with the ring.

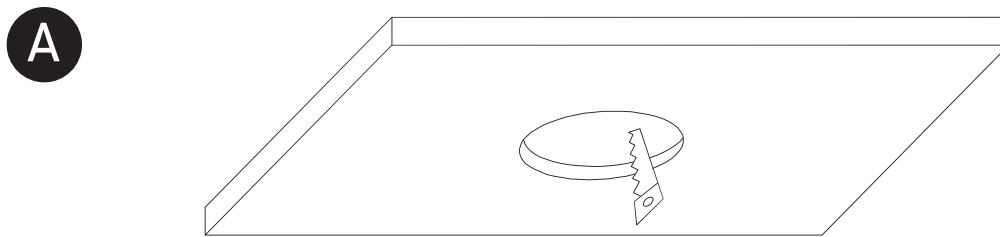

CUTOUT HOLE: 75mm

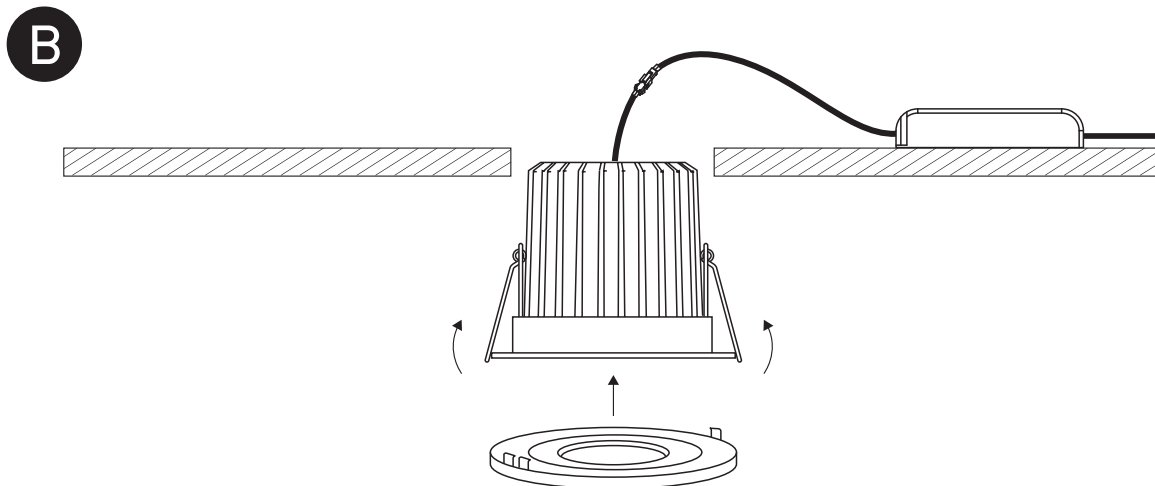

Adjust the ring.

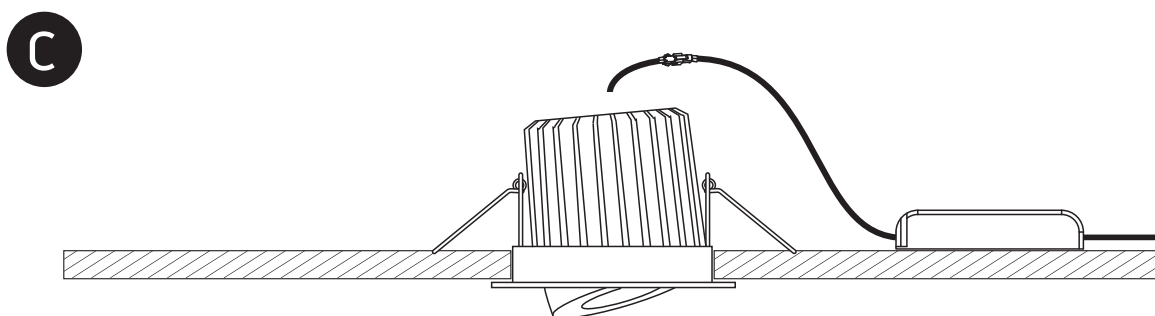

Warnings:

1. Make sure that the product is installed properly before connecting to electricity.
2. Do not cover the fitting.
3. Maintenance and installation should only be carried out by a professional electrician.