

# INSTALLATION MANUAL

38120L, 38135L, 38248L

ecolight



80 CRI

Complete with driver.

one  
LIGHT

230V | SMD 2835 | 20W | IP20 | Aluminium + PC

230V | SMD 2835 | 35W | IP20 | Aluminium + PC

230V | SMD 2835 | 48W | IP20 | Aluminium + PC

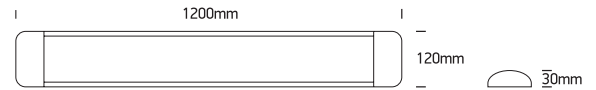
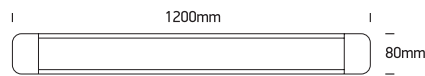
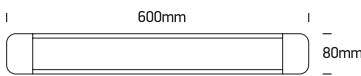

A

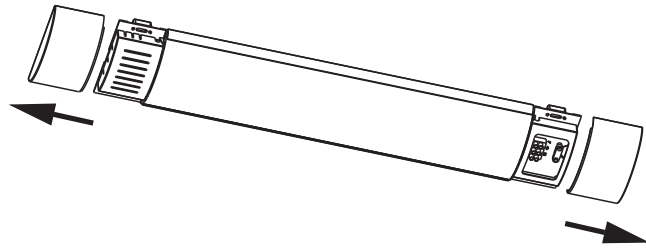

B

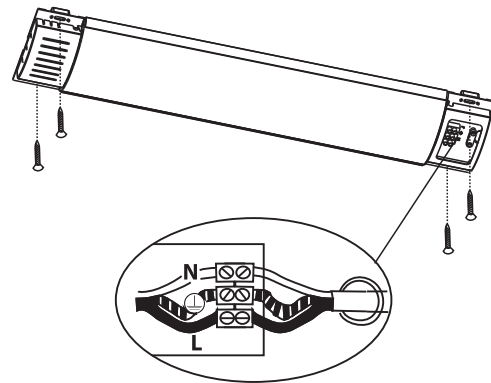

C

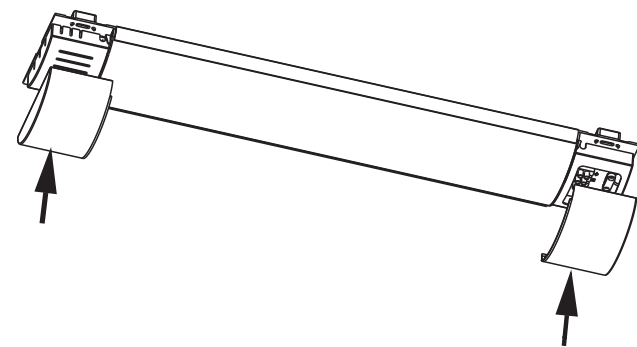

D

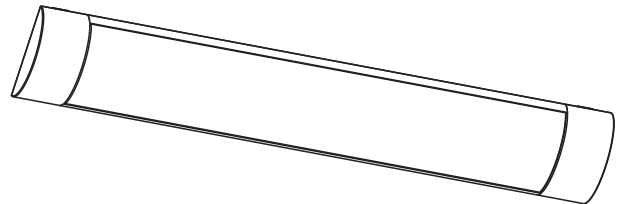

## Warnings:

1. Make sure that the product is installed properly before connecting to electricity.
2. Do not cover the fitting.
3. Maintenance and installation should only be carried out by a professional electrician.