

INSTALLATION MANUAL

42001TR, 42002TR

48V | 1m/2m Recessed Profile | ON/OFF / DALI | Aluminium
 Max 10m/driver | Max 400W/circuit

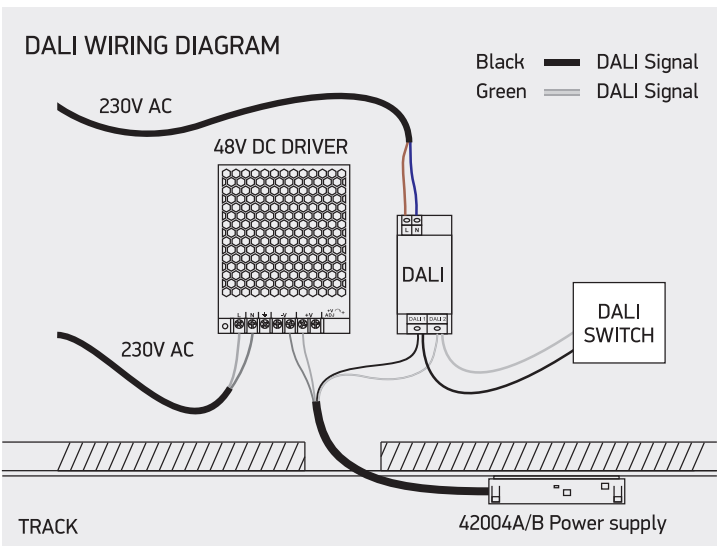
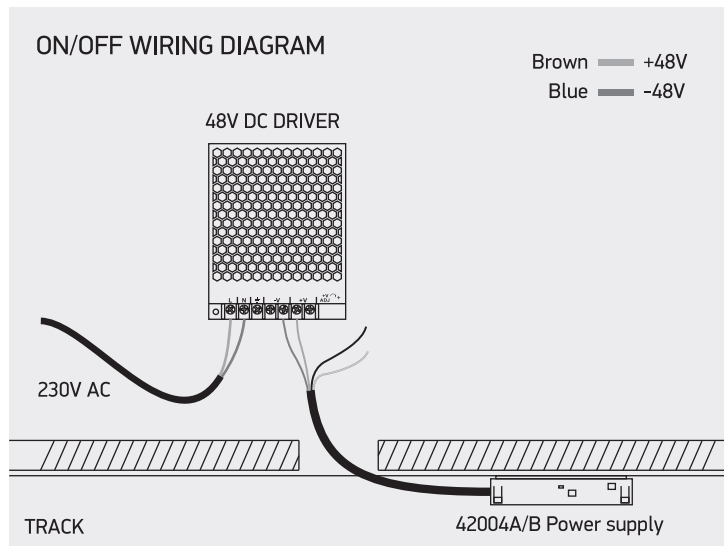
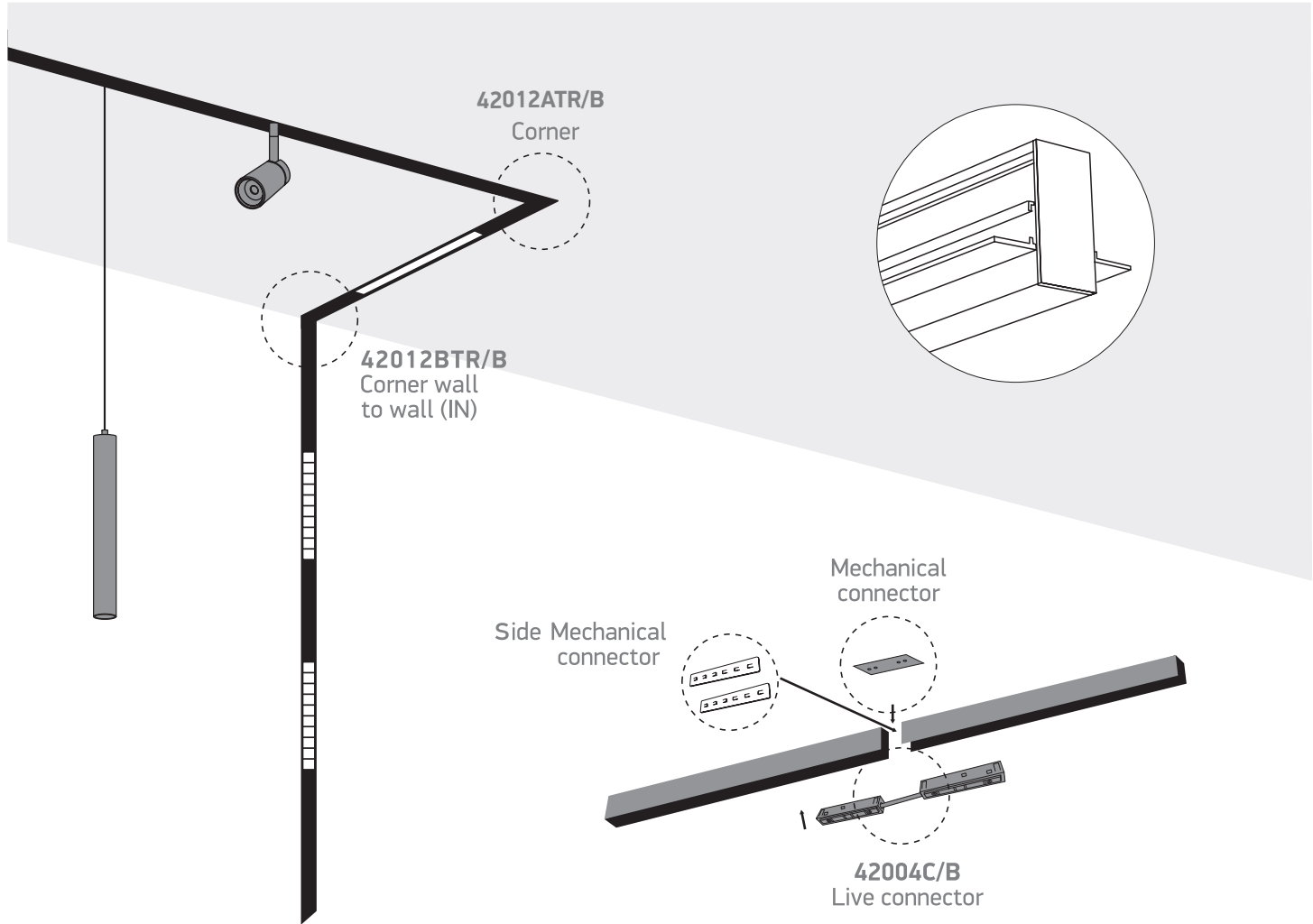

Warnings:

1. Make sure that the product is installed properly before connecting to electricity.
2. Do not cover the fitting.
3. Maintenance and installation should only be carried out by a professional electrician.

INSTALLATION MANUAL

42001TR, 42002TR

48V | 1m/2m Recessed Profile | ON/OFF / DALI | Aluminium
Max 10m/driver | Max 400W/circuit



12mm

40mm

75mm

74mm

one
LIGHT

A

CUT OUT HOLE:
42mm

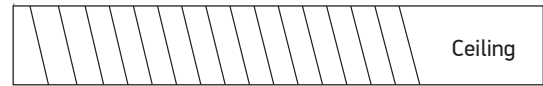
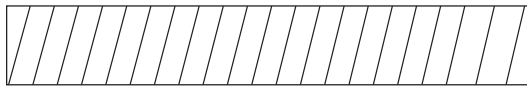

Mark the plasterboard ceiling and cut a hole for the profile.

B

Slide profile into ceiling

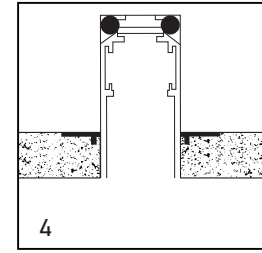
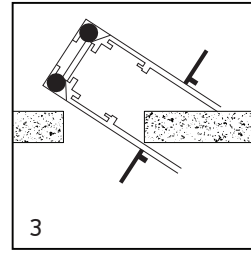
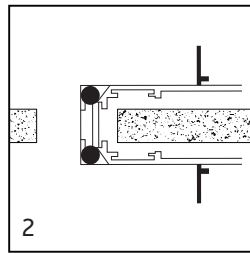
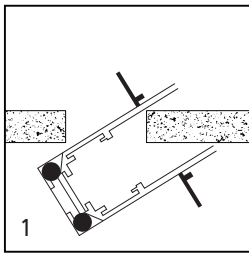

C

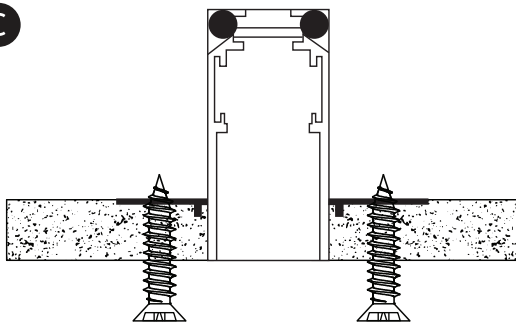

D

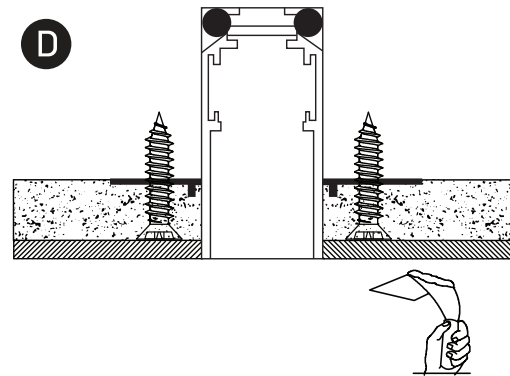

E

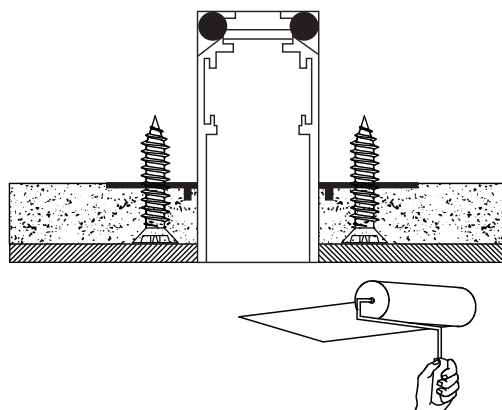

Warnings:

1. Make sure that the product is installed properly before connecting to electricity.
2. Do not cover the fitting.
3. Maintenance and installation should only be carried out by a professional electrician.