

# INSTALLATION MANUAL

50406B

**ecolight**



90  
CRI

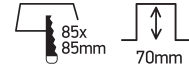

230V | COB LED | 16W | IP20 | Die cast

Complete with 400mA driver.

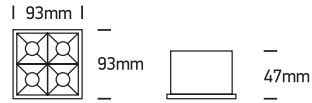

**one**  
LIGHT

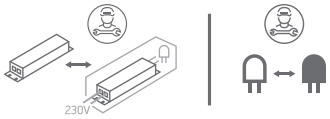

**A**

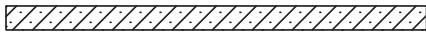

**B**

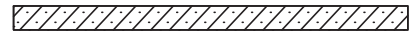
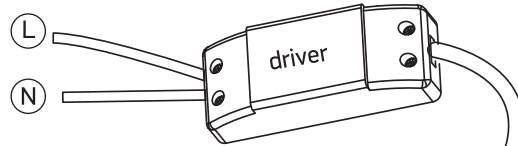

**C**

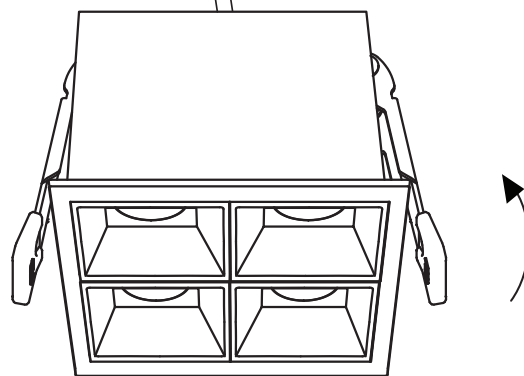

## Warnings:

1. Make sure that the product is installed properly before connecting to electricity.
2. Do not cover the fitting.
3. Maintenance and installation should only be carried out by a professional electrician.