

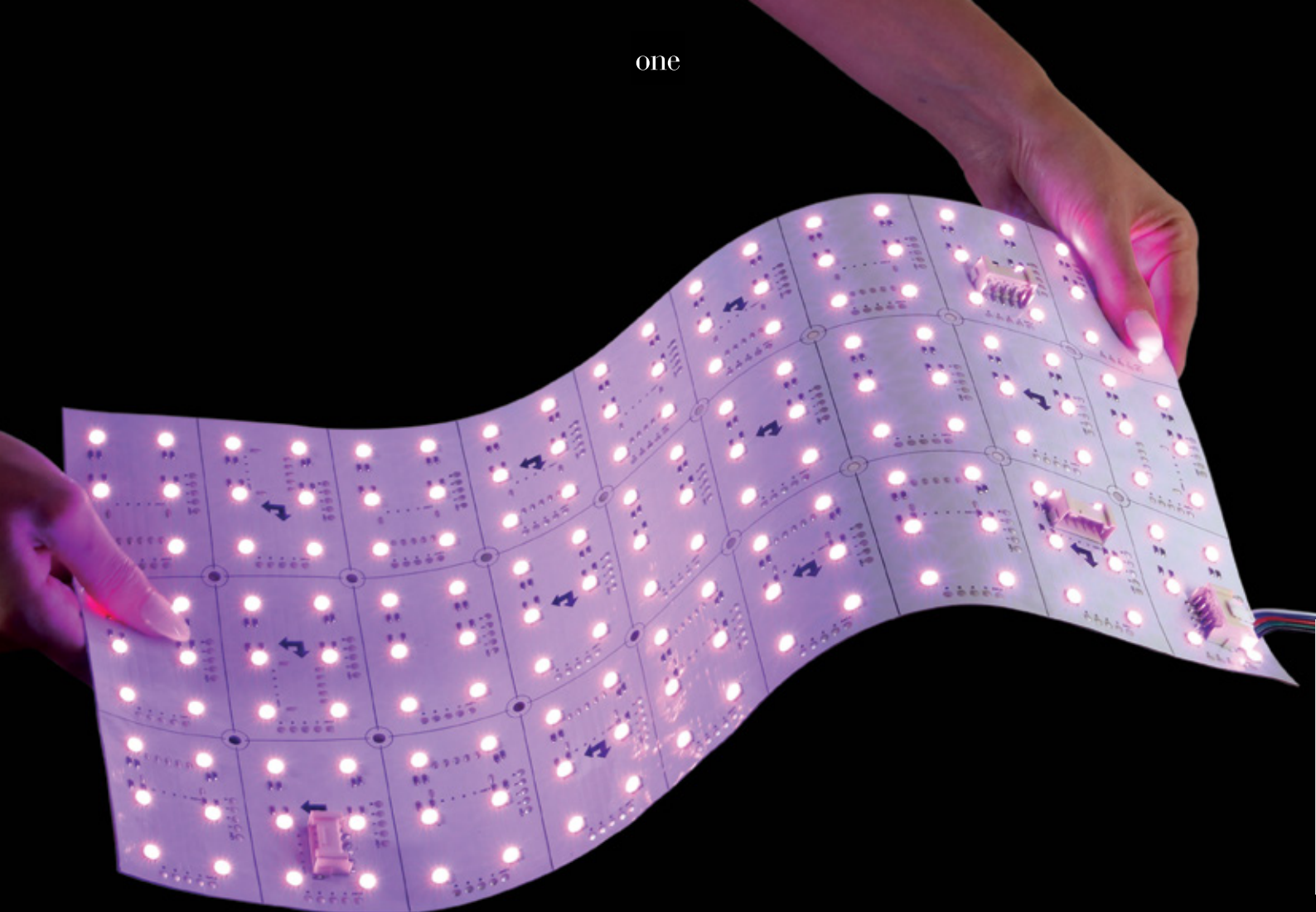

# Strips & Profiles

Pages 219-274

# 08



# The Flex Tiles

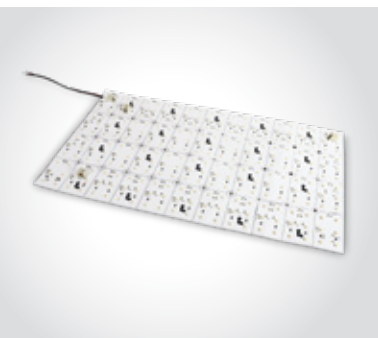

**7848** | 10W | SMD 2835 | 288LEDs/pc | Flex tile

3M Double face adhesive.

**IP20**

Connect up to 10pcs.

Complete with 2pcs power supply & 2pcs connectors.

Dimming remote control. Order code 20030.

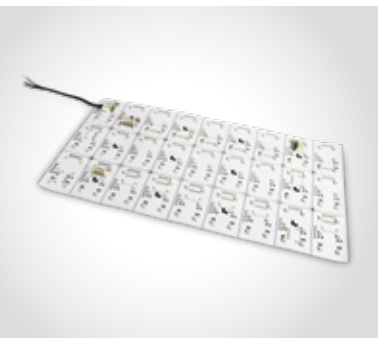

**7848/RGBW** | 24W | SMD 5050 | 162LEDs/pc | Flex tile

3M Double face adhesive.

**IP20**

Connect up to 10pcs.

Complete with 2pcs power supply & 2pcs connectors.

Dimming remote control. Order code 20036.

Order Code	Light Colour	CCT (K)	Watts	Lumen (lm)	Input	Class		Notes
<b>7848/C</b>	Cool white	4000K	10W	900lm	24V DC		2	Requires 24V DC driver
<b>7848/W</b>	Warm white	3000K	10W	850lm	24V DC		2	Requires 24V DC driver
<b>7848/RGBW</b>	RGB + Warm white	RGB + 3000K	RGB 18W + WW 6W	480lm (3000K)	24V DC		2	Requires 24V DC driver



## The Ultra Slim Range 24V

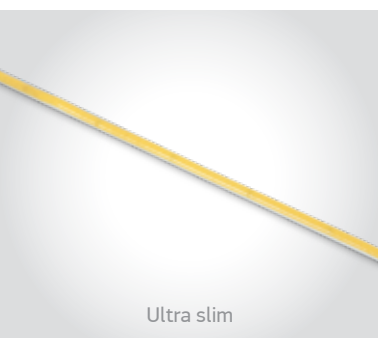

**7843** | 4W/m | COB LED | 480LEDs/m | Ultra slim

3M Double face adhesive.

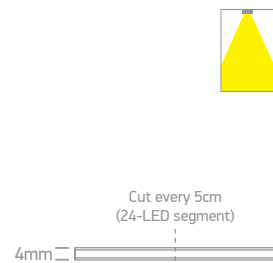
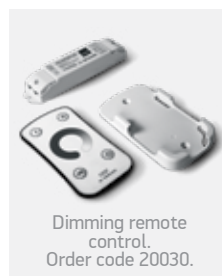

**7823** | 9,6W/m | SMD 2216 | 140LEDs/m | Ultra slim

3M Double face adhesive.

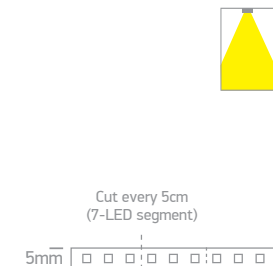
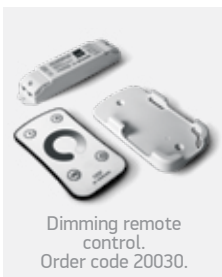
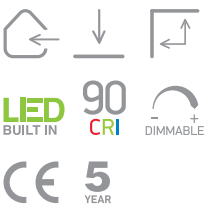

**7833** | 14,4W/m | SMD 2110 | 196LEDs/m | Ultra slim

3M Double face adhesive.

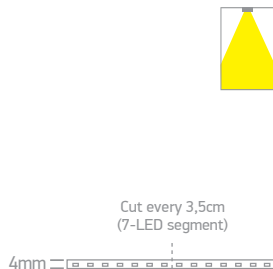
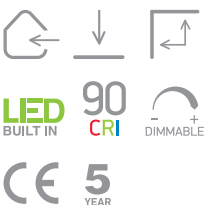

Order Code	Light Colour	CCT (K)	Watts	Lumen (lm)	Input	Class	Notes
7843/C	Cool white	4000K	4W/m	440lm/m	24V DC	III	Requires 24V DC driver
7843/W	Warm white	3000K	4W/m	410lm/m	24V DC	III	Requires 24V DC driver
7823/C	Cool white	4000K	9,6W/m	970lm/m	24V DC	III	Requires 24V DC driver
7823/W	Warm white	3000K	9,6W/m	864lm/m	24V DC	III	Requires 24V DC driver
7823/EW	Extra warm white	2700K	9,6W/m	768lm/m	24V DC	III	Requires 24V DC driver
7833/C	Cool white	4000K	14,4W/m	1300lm/m	24V DC	III	Requires 24V DC driver
7833/W	Warm white	3000K	14,4W/m	1200lm/m	24V DC	III	Requires 24V DC driver
7833/EW	Extra warm white	2700K	14,4W/m	1160lm/m	24V DC	III	Requires 24V DC driver



## The 4,8W/m Indoor 24V



7820 | 4,8W/m | SMD 2216 | 70LEDs/m

3M Double face adhesive.

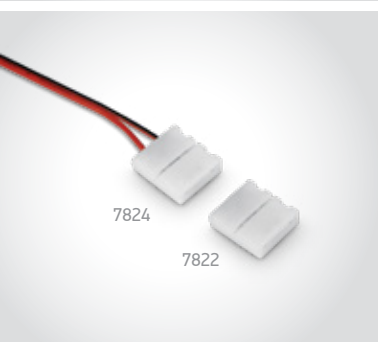
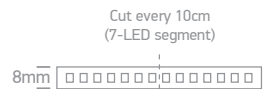
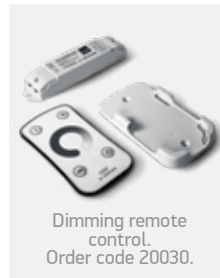
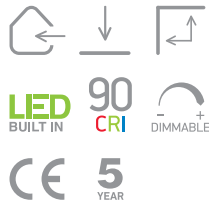

### Accessories for 7820



7824 Power supply cable  
7822 Connector

Order Code	Light Colour	CCT (K)	Watts	Lumen (lm)	Input	Class		Notes
7820/D	Daylight	6000K	4,8W/m	490lm/m	24V DC		40	Requires 24V DC driver
7820/C	Cool white	4000K	4,8W/m	490lm/m	24V DC		40	Requires 24V DC driver
7820/W	Warm white	3000K	4,8W/m	432lm/m	24V DC		40	Requires 24V DC driver
7820/EW	Extra warm white	2700K	4,8W/m	384lm/m	24V DC		40	Requires 24V DC driver
7820/UW	Ultra warm white	2200K	4,8W/m	384lm/m	24V DC		40	Requires 24V DC driver

# The 4,8W/m Outdoor 24V



7820W | 4,8W/m | SMD 2216 | 70LEDs/m | Silicone

3M Double face adhesive.

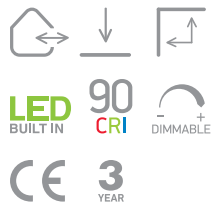

IP68

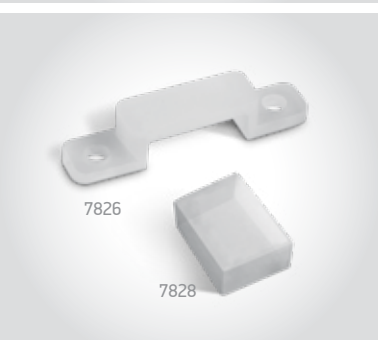
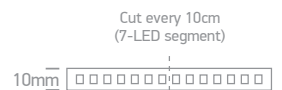
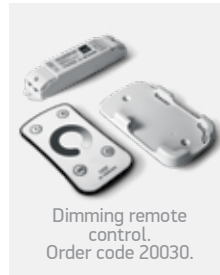
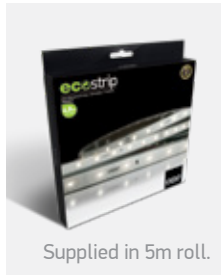

## Accessories for 7820W



7826 Mounting clip  
7828 End cap

Order Code	Light Colour	CCT (K)	Watts	Lumen (lm)	Input	Class	Box	Notes
7820W/D	Daylight	6000K	4,8W/m	432lm/m	24V DC	III	40	Requires 24V DC driver / Avoid direct sunlight
7820W/C	Cool white	4000K	4,8W/m	432lm/m	24V DC	III	40	Requires 24V DC driver / Avoid direct sunlight
7820W/W	Warm white	3000K	4,8W/m	390lm/m	24V DC	III	40	Requires 24V DC driver / Avoid direct sunlight
7820W/EW	Extra warm white	2700K	4,8W/m	375lm/m	24V DC	III	40	Requires 24V DC driver / Avoid direct sunlight

# The 9,6W/m 24V

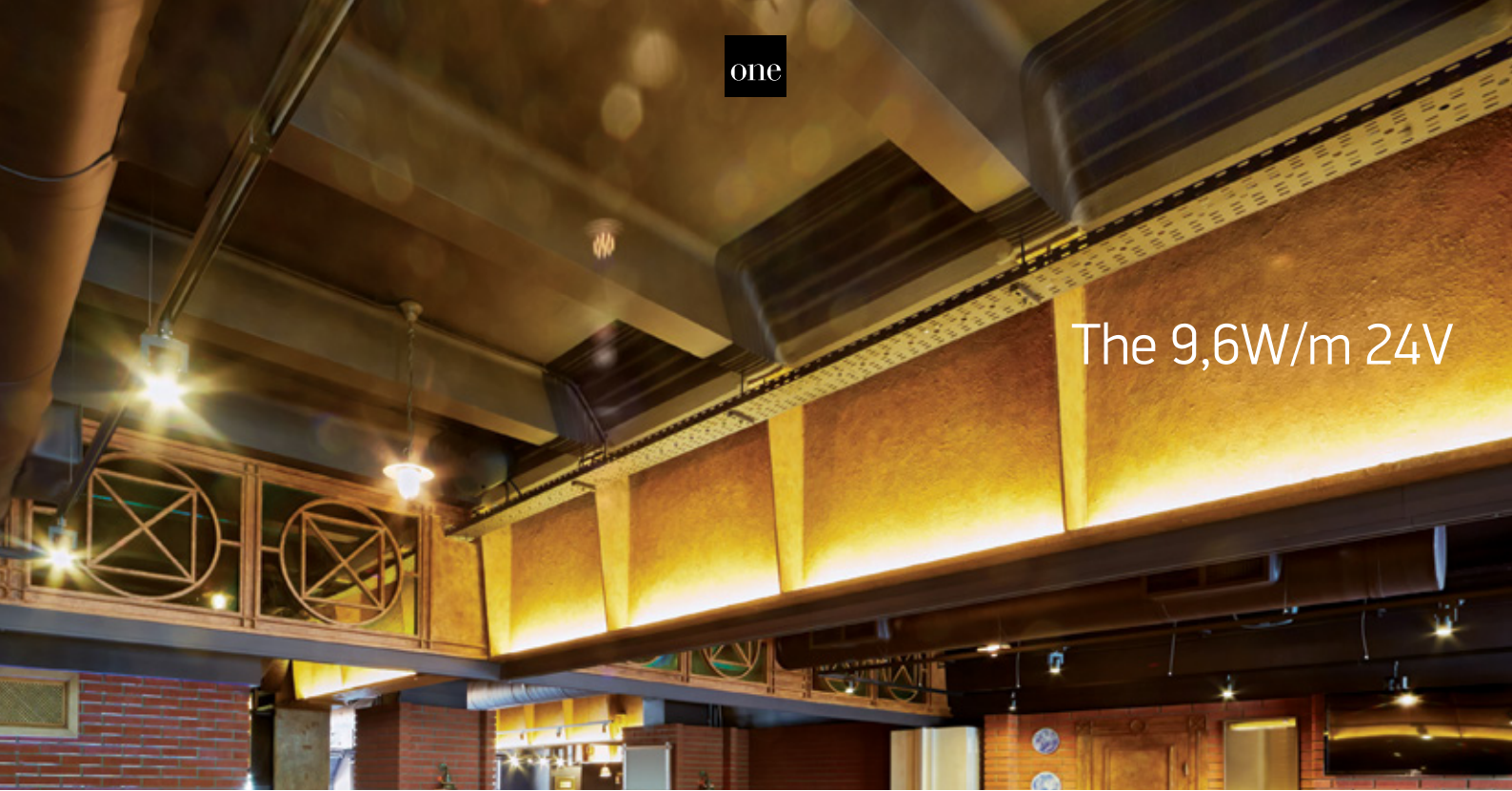

**7829A** | 9,6W/m | SMD 2835 | 70LEDs/m

3M Double face adhesive.

**new**  
IP20

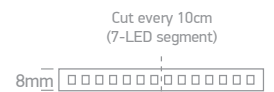
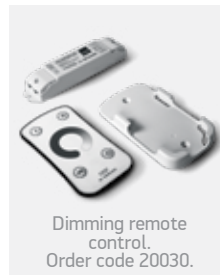
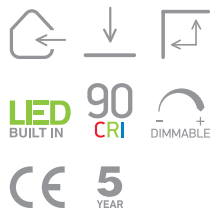

**7829** | 9,6W/m | SMD 2216 | 140LEDs/m

3M Double face adhesive.

IP20

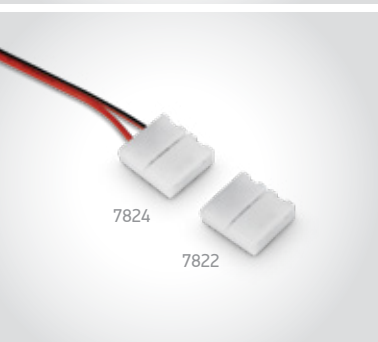
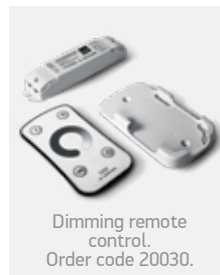
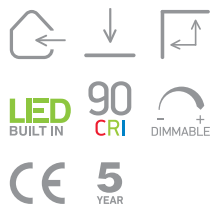

### Accessories for 7829A & 7829



7824 Power supply cable  
7822 Connector

Order Code	Light Colour	CCT (K)	Watts	Lumen (lm)	Input	Class	Icon	Notes
7829A/C	Cool white	4000K	9,6W/m	970lm/m	24V DC	III	40	Requires 24V DC driver
7829A/W	Warm white	3000K	9,6W/m	864lm/m	24V DC	III	40	Requires 24V DC driver
7829A/EW	Extra warm white	2700K	9,6W/m	768lm/m	24V DC	III	40	Requires 24V DC driver
7829/C	Cool white	4000K	9,6W/m	970lm/m	24V DC	III	40	Requires 24V DC driver
7829/W	Warm white	3000K	9,6W/m	864lm/m	24V DC	III	40	Requires 24V DC driver
7829/EW	Extra warm white	2700K	9,6W/m	768lm/m	24V DC	III	40	Requires 24V DC driver



## The 14,4W/m CRI97 Indoor 24V Full spectrum



**7835C** | 14,4W/m | SMD 2835 | 80LEDs/m

3M Double face adhesive.

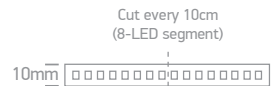
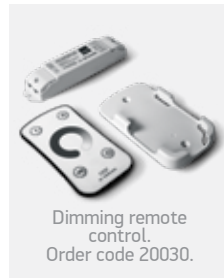
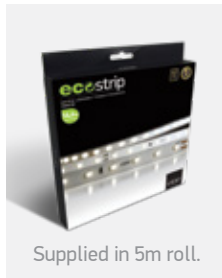
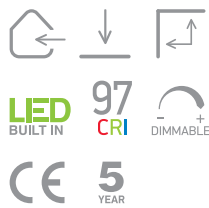

IP20

### Accessories for 7835C

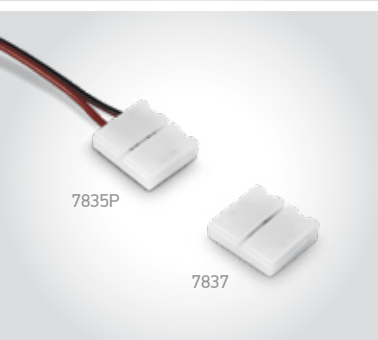

7835P Power supply cable  
7837 Connector

Order Code	Light Colour	CCT (K)	Watts	Lumen (lm)	Input	Class	Box	Notes
7835C/W	Warm white	3000K	14,4W/m	1512lm/m	24V DC	III	40	Requires 24V DC driver





## The 14,4W/m Indoor 24V



**7835** | 14,4W/m | SMD 2835 | 70LEDs/m

3M Double face adhesive.

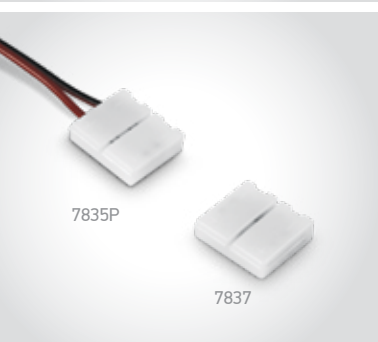
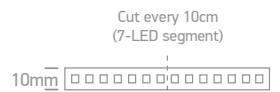
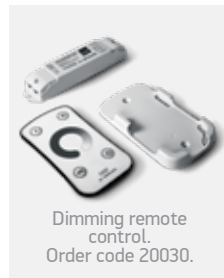
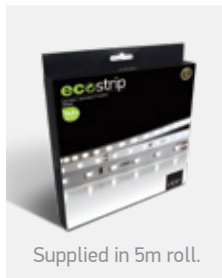
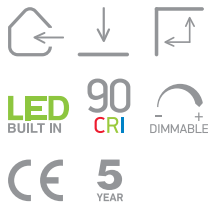

### Accessories for 7835



7835P Power supply cable  
7837 Connector

Order Code	Light Colour	CCT (K)	Watts	Lumen (lm)	Input	Class		Notes
<b>7835/D</b>	Daylight	6000K	14,4W/m	1300lm/m	24V DC		40	Requires 24V DC driver
<b>7835/C</b>	Cool white	4000K	14,4W/m	1300lm/m	24V DC		40	Requires 24V DC driver
<b>7835/W</b>	Warm white	3000K	14,4W/m	1200lm/m	24V DC		40	Requires 24V DC driver
<b>7835/EW</b>	Extra warm white	2700K	14,4W/m	1125lm/m	24V DC		40	Requires 24V DC driver
<b>7835/UW</b>	Ultra warm white	2200K	14,4W/m	1125lm/m	24V DC		40	Requires 24V DC driver



## The 14,4W/m Outdoor 24V



**7835W** | 14,4W/m | SMD 2835 | 70LEDs/m | Silicone

3M Double face adhesive.

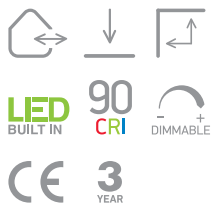

IP68

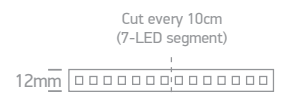
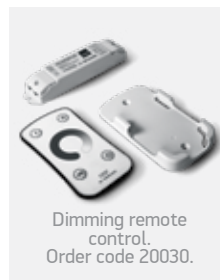
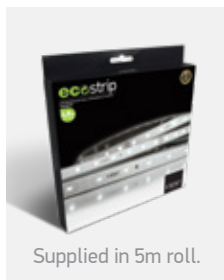

**7827** | Mounting clip for 7835W



Order Code	Light Colour	CCT (K)	Watts	Lumen (lm)	Input	Class	Box	Notes
7835W/D	Daylight	6000K	14,4W/m	1170lm/m	24V DC	III	40	Requires 24V DC driver / Avoid direct sunlight
7835W/C	Cool white	4000K	14,4W/m	1170lm/m	24V DC	III	40	Requires 24V DC driver / Avoid direct sunlight
7835W/W	Warm white	3000K	14,4W/m	1050lm/m	24V DC	III	40	Requires 24V DC driver / Avoid direct sunlight
7835W/EW	Extra warm white	2700K	14,4W/m	1050lm/m	24V DC	III	40	Requires 24V DC driver / Avoid direct sunlight

# The COB Strip



**7839** | 4W/m | COB LED | 320LEDs/m

3M Double face adhesive.

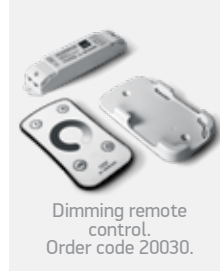
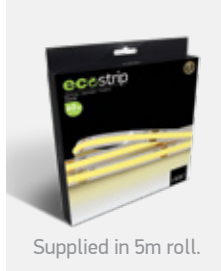
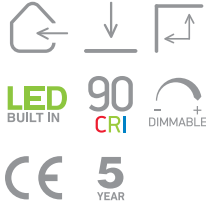

IP20



**7844** | 8W/m | COB LED | 320LEDs/m

3M Double face adhesive.

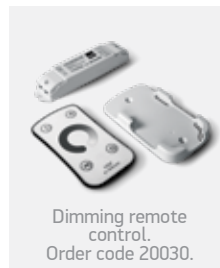
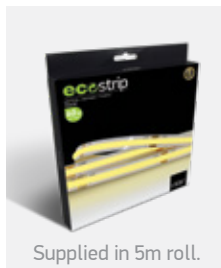
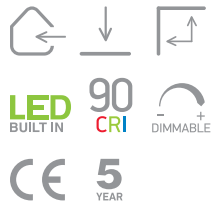

IP20



**7846** | 14W/m | COB LED | 512LEDs/m

3M Double face adhesive.

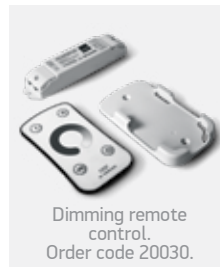
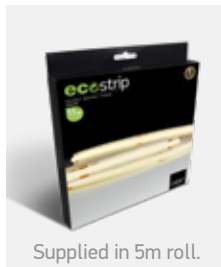

IP20



Order Code	Light Colour	CCT (K)	Watts	Lumen (lm)	Input	Class		Notes
7839/C	Cool white	4000K	4W/m	400lm/m	24V DC		40	Requires 24V DC driver
7839/W	Warm white	3000K	4W/m	380lm/m	24V DC		40	Requires 24V DC driver
7839/EW	Extra warm white	2700K	4W/m	360lm/m	24V DC		40	Requires 24V DC driver
7844/C	Cool white	4000K	8W/m	810lm/m	24V DC		40	Requires 24V DC driver
7844/W	Warm white	3000K	8W/m	730lm/m	24V DC		40	Requires 24V DC driver
7844/EW	Extra warm white	2700K	8W/m	680lm/m	24V DC		40	Requires 24V DC driver
7846/C	Cool white	4000K	14W/m	1470lm/m	24V DC		50	Requires 24V DC driver
7846/W	Warm white	3000K	14W/m	1420lm/m	24V DC		50	Requires 24V DC driver
7846/EW	Extra warm white	2700K	14W/m	1200lm/m	24V DC		50	Requires 24V DC driver

# The IP COB Strip

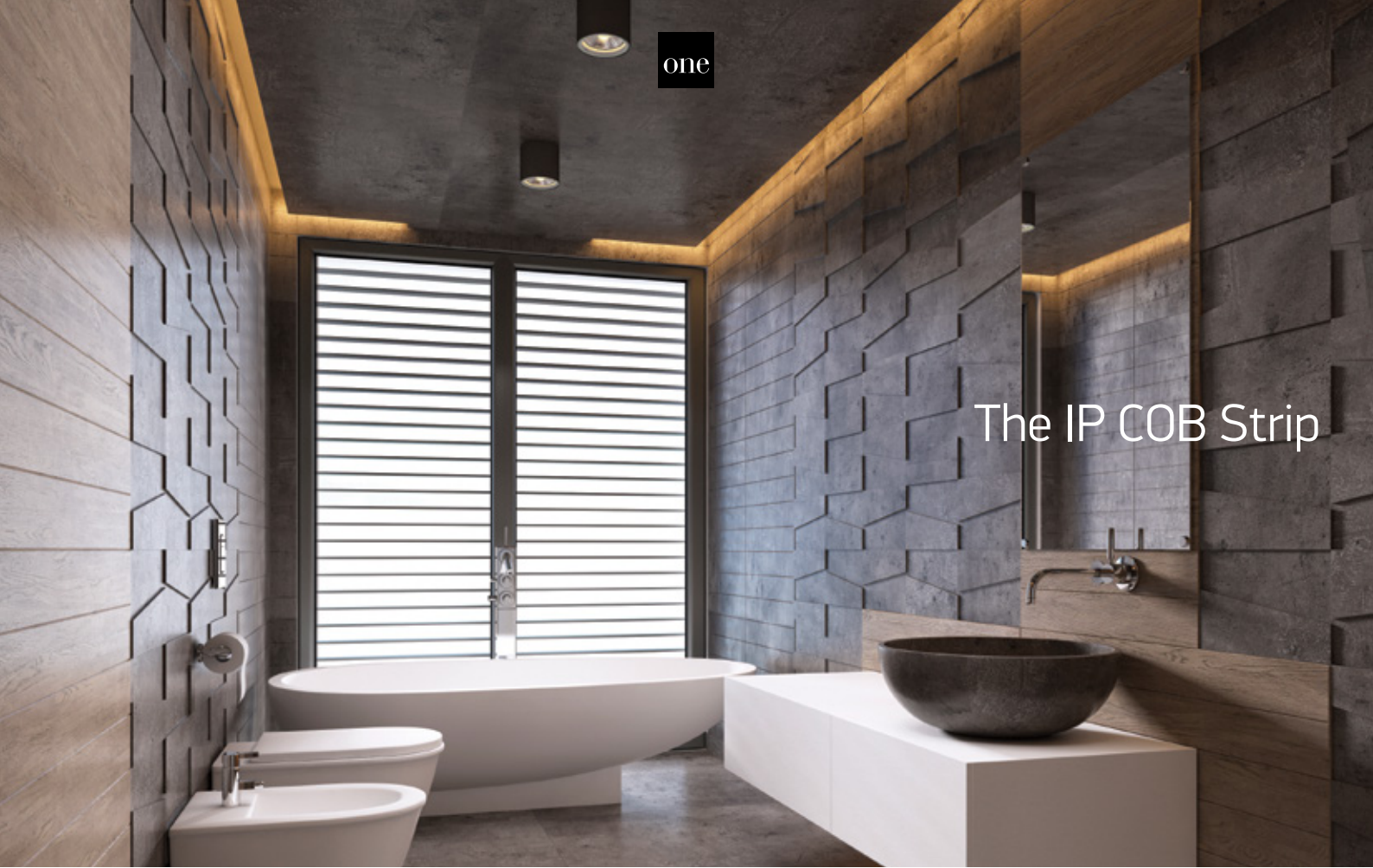

**7846W** | 14W/m | COB LED | 512LEDs/m | Silicone

3M Double face adhesive.

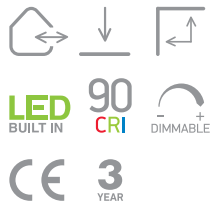

IP67

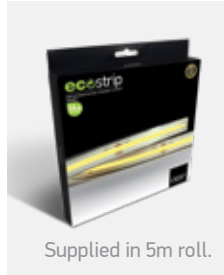

Supplied in 5m roll.

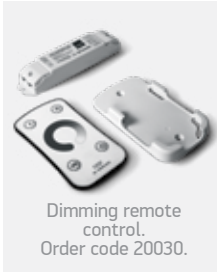

Dimming remote control.  
Order code 20030.

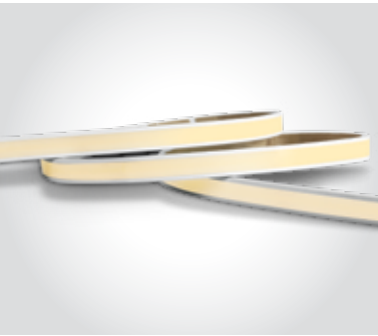

**7846WA** | 10W/m | COB LED | 512LEDs/m | Silicone

3M Double face adhesive.



IP68

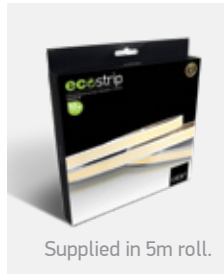

Supplied in 5m roll.

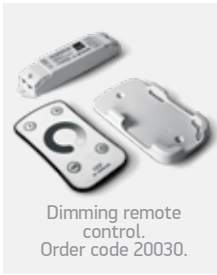

Dimming remote control.  
Order code 20030.

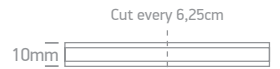

7846WP 24V Power supply for 7846WA



7846WC Connector for 7846WA



7846WB Corner connector for 7846WA



7827A Mounting clip for 7846W and 7846WA

Order Code	Light Colour	CCT (K)	Watts	Lumen (lm)	Input	Class	Box	Notes
7846W/C	Cool white	4000K	14W/m	1350lm/m	24V DC	III	40	Requires 24V DC driver / Avoid direct sunlight
7846W/W	Warm white	3000K	14W/m	1220lm/m	24V DC	III	40	Requires 24V DC driver / Avoid direct sunlight
7846WA/C	Cool white	4000K	10W/m	700lm/m	24V DC	III	50	Requires 24V DC driver / Avoid direct sunlight
7846WA/W	Warm white	3000K	10W/m	650lm/m	24V DC	III	50	Requires 24V DC driver / Avoid direct sunlight

# Connect In One Length Range 24V



**7820L** | 4,8W/m | SMD 2216 | 60LEDs/m

Can be connected in 15m full length / 3M Double face adhesive.

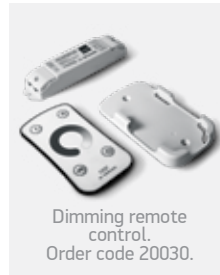
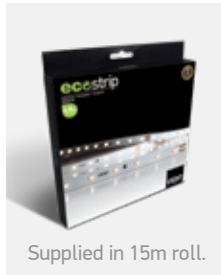
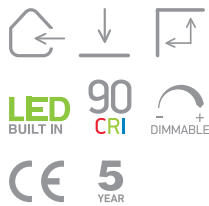

**7820WL** | 4,8W/m | SMD 2216 | 60LEDs/m | Silicone

Can be connected in 15m full length / 3M Double face adhesive.

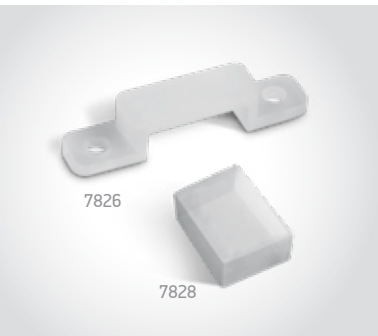
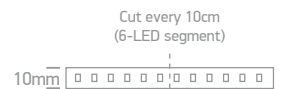
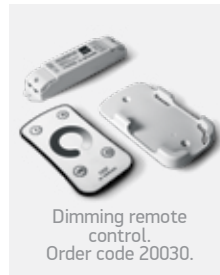
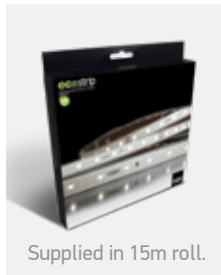
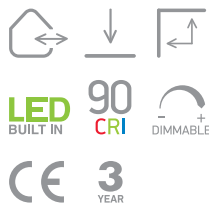

### Accessories for 7820WL



7826 Mounting clip  
7828 End cap

Order Code	Light Colour	CCT (K)	Watts	Lumen (lm)	Input	Class	⊞	Notes
<b>7820L/EW</b>	Extra warm white	2700K	4,8W/m	312lm/m	24V DC	⊞	40	Requires 24V DC driver
<b>7820WL/W</b>	Warm white	3000K	4,8W/m	302lm/m	24V DC	⊞	20	Requires 24V DC driver / Avoid direct sunlight



## The Vertical Light Range 24V



**7820V** | 4,8W/m | SMD 3014 | 60LEDs/m | Vertical light

3M Double face adhesive.

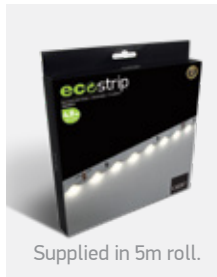
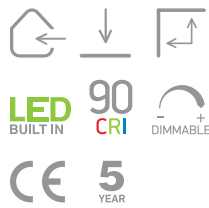

Supplied in 5m roll.

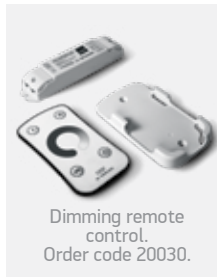

Dimming remote control.  
Order code 20030.

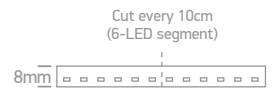

IP20



**7835V** | 14,4W/m | SMD 3014 | 120LEDs/m | Vertical light

3M Double face adhesive.

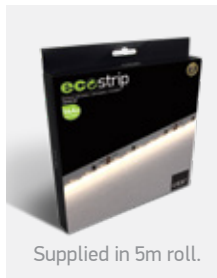
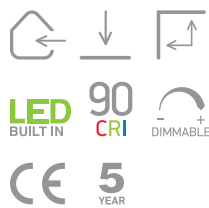

Supplied in 5m roll.

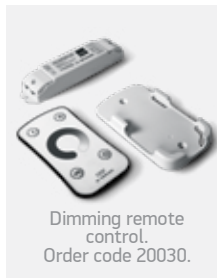

Dimming remote control.  
Order code 20030.

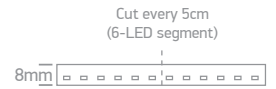

IP20

### Accessories for 7820V & 7835V

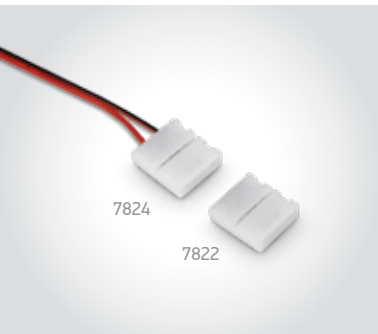

7824 Power supply cable  
7822 Connector

Order Code	Light Colour	CCT (K)	Watts	Lumen (lm)	Input	Class	Box	Notes
7820V/C	Cool white	4000K	4,8W/m	500lm/m	24V DC	III	40	Requires 24V DC driver
7820V/W	Warm white	3000K	4,8W/m	450lm/m	24V DC	III	40	Requires 24V DC driver
7835V/W	Warm white	3000K	14,4W/m	1152lm/m	24V DC	III	40	Requires 24V DC driver

# The 19,2W/m Indoor 24V



**7825** | 19,2W/m | SMD 2835 | 140LEDs/m

3M Double face adhesive.

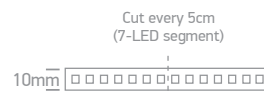
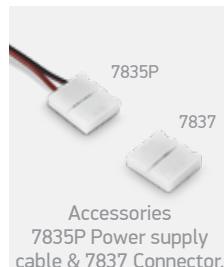
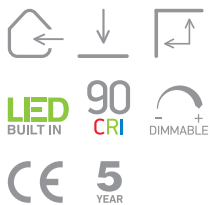

**7870** | 19,2W/m | SMD 2216 | 238LEDs/m

3M Double face adhesive.

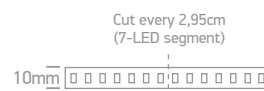
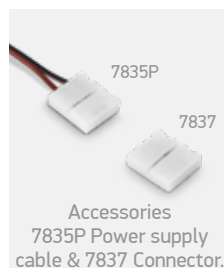

**7875** | 19,2W/m | SMD 2216 | 240LEDs/m

3M Double face adhesive.

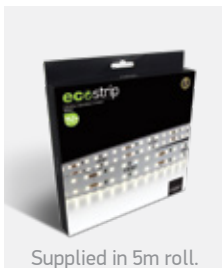

Order Code	Light Colour	CCT (K)	Watts	Lumen (lm)	Input	Class		Notes
<b>7825/C</b>	Cool white	4000K	19,2W/m	1728lm/m	24V DC		40	Requires 24V DC driver
<b>7825/W</b>	Warm white	3000K	19,2W/m	1536lm/m	24V DC		40	Requires 24V DC driver
<b>7825/EW</b>	Extra warm white	2700K	19,2W/m	1536lm/m	24V DC		40	Requires 24V DC driver
<b>7870/C</b>	Cool white	4000K	19,2W/m	1940lm/m	24V DC		40	Requires 24V DC driver
<b>7870/W</b>	Warm white	3000K	19,2W/m	1728lm/m	24V DC		40	Requires 24V DC driver
<b>7875/C</b>	Cool white	4000K	19,2W/m	1750lm/m	24V DC		40	Requires 24V DC driver
<b>7875/W</b>	Warm white	3000K	19,2W/m	1700lm/m	24V DC		40	Requires 24V DC driver



## The 24W/m Indoor 24V



**7845** | 24W/m | SMD 2216 | 280LEDs/m

3M Double face adhesive.

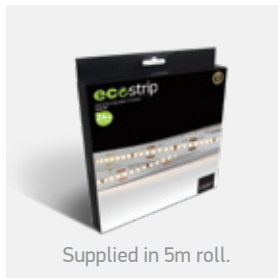

IP20

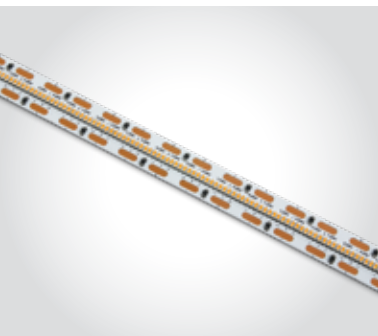
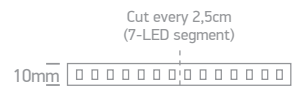

**7887** | 24W/m | SMD 2110 | 700LEDs/m

3M Double face adhesive.

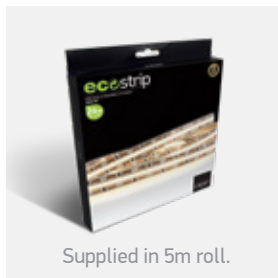

IP20



Order Code	Light Colour	CCT (K)	Watts	Lumen (lm)	Input	Class	Box	Notes
7845/C	Cool white	4000K	24W/m	2450lm/m	24V DC	II	40	Requires 24V DC driver
7845/W	Warm white	3000K	24W/m	2200lm/m	24V DC	II	40	Requires 24V DC driver
7887/W	Warm white	3000K	24W/m	2050lm/m	24V DC	II	40	Requires 24V DC driver



# The High Power Strips 24V



**7880** | 28,8W/m | SMD 2835 | 120LEDs/m

3M Double face adhesive.

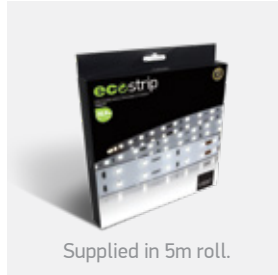
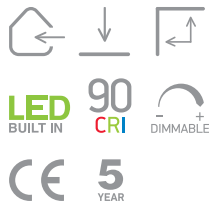

Supplied in 5m roll.

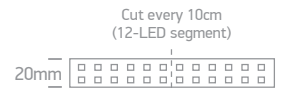

**7882** | 42W/m | SMD 2835 | 240LEDs/m

3M Double face adhesive.

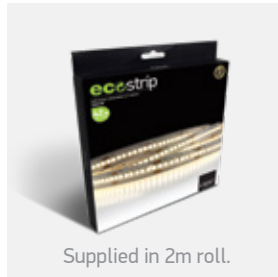
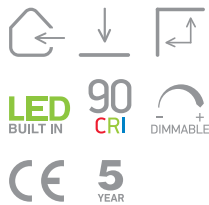

Supplied in 2m roll.



**7884** | 33W/m | SMD 2835 | 320LEDs/m

3M Double face adhesive.

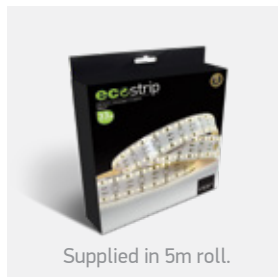
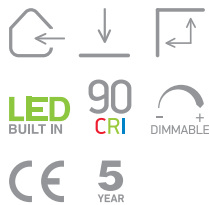

Supplied in 5m roll.

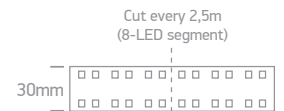

**7885** | 48W/m | SMD 2835 | 294LEDs/m

3M Double face adhesive.

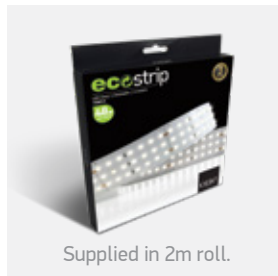

Supplied in 2m roll.

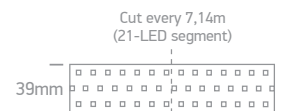

Order Code	Light Colour	CCT (K)	Watts	Lumen (lm)	Input	Class	Box	Notes
7880/C	Cool white	4000K	28,8W/m	2304lm/m	24V DC	III	40	Requires 24V DC driver
7880/W	Warm white	3000K	28,8W/m	2260lm/m	24V DC	III	40	Requires 24V DC driver
7882/W	Warm white	3000K	42W/m	6100lm/m	24V DC	III	40	Requires 24V DC driver
7884/C	Cool white	4000K	33W/m	4700lm/m	24V DC	III	20	Requires 24V DC driver
7884/W	Warm white	3000K	33W/m	4100lm/m	24V DC	III	20	Requires 24V DC driver
7885/C	Cool white	4000K	48W/m	4850lm/m	24V DC	III	20	Requires 24V DC driver
7885/W	Warm white	3000K	48W/m	4400lm/m	24V DC	III	20	Requires 24V DC driver

one



2700K



6500K

The 20W/m Variable Colour Temperature



7835/DEW | 20W/m | SMD 2835 | 120LEDs/m

3M Double face adhesive.

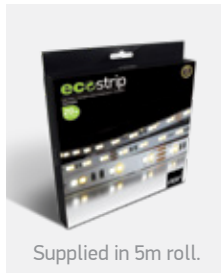
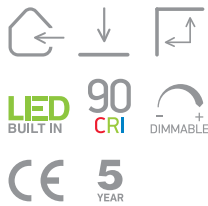

Supplied in 5m roll.

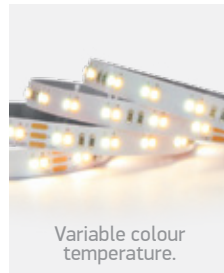

Variable colour temperature.



20032 | 12-24V DC | Variable colour temperature controller & dimmer | 2 channels x 3A



Remote controller for changing colour temperature from extra warm white to daylight. Suitable for use with LED strips 7835/DEW. 50 meters range, includes dimmer control and programme mode.

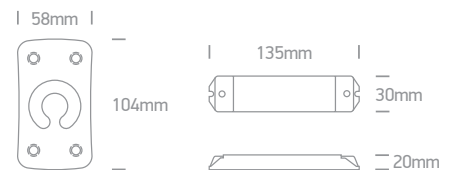

Order Code	Light Colour	CCT (K)	Watts	Lumen (lm)	Input	Class	Notes
7835/DEW	Extra warm white - Daylight	2700K-6500K	20W/m	700lm/m (EW) + 900lm/m (D)	24V DC	40	Requires 24V DC driver



# The Blue LED Strips 24V



7820/BL | 4,8W/m | SMD 3528 | 60LEDs/m

3M Double face adhesive.



**LED**  
BUILT IN DIMMABLE CE

5  
YEAR

IP20



Supplied in 5m roll.



Dimming remote control.  
Order code 20030.



Cut every 10cm  
(6-LED segment)



7820W/BL | 4,8W/m | SMD 3528 | 60LEDs/m | Silicone

3M Double face adhesive.



**LED**  
BUILT IN DIMMABLE CE

3  
YEAR

IP68



Supplied in 5m roll.



Dimming remote control.  
Order code 20030.



Cut every 10cm  
(6-LED segment)



Order Code	Light Colour	Input	Input	Class		Notes
7820/BL	Blue	4,8W/m	24V DC		40	Requires 24V DC driver
7820W/BL	Blue	4,8W/m	24V DC		40	Requires 24V DC driver / Avoid direct sunlight



# RGB Set



RGB

IP20

7820A/RGB | 2W/m/color | SMD 5050 | 30LEDs/m

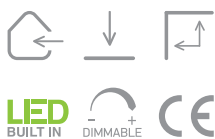

3 YEAR

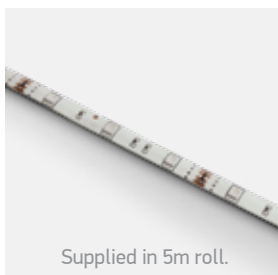

Supplied in 5m roll.



10mm

Order Code	Light Colour	CCT (K)	Watts	Input	Class		Notes
7820A/RGB	RGB	-	2W/m/color	230V / 12V DC		10	Set of LED strip + remote

# The RGB & RGBW Strips 24V



**7830/RGB** | 14,4W/m | SMD 5050 | 60LEDs/m

Supplied in 5m roll / 3M Double face adhesive.

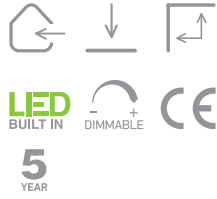

Dimming remote control.  
Order code 20034.



DALI & Push to DIM controller.  
Order code 89100LP.

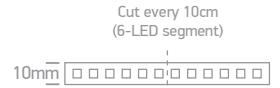

RGB



## Accessories for 7830/RGB

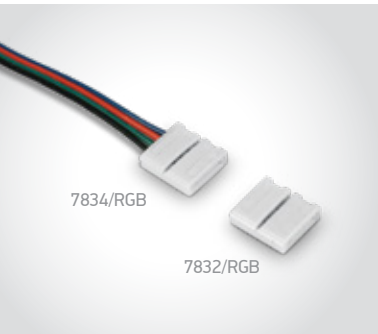

7834/RGB Power supply cable  
7832/RGB Connector

7834/RGB

7832/RGB



**7830/RGBW** | 19,2W/m | SMD 5050 | 60LEDs/m

Supplied in 5m roll / 3M Double face adhesive.

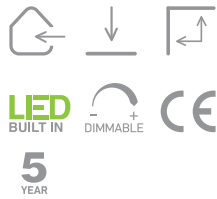

Dimming remote control.  
Order code 20036.



DALI & Push to DIM controller.  
Order code 89100LP.

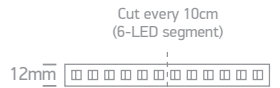

RGB+W



**7846/RGB** | 15W/m | COB LED | 840LEDs/m | RGB

Supplied in 5m roll / 3M Double face adhesive.

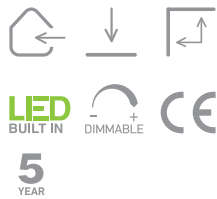

Dimming remote control.  
Order code 20034.



DALI & Push to DIM controller.  
Order code 89100LP.

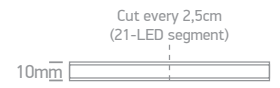

RGB

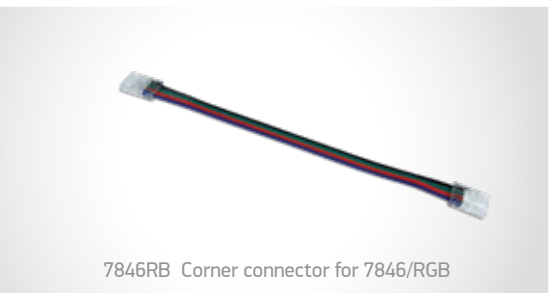

7846RB Corner connector for 7846/RGB



7846RC Connector for 7846/RGB



7846RP Power supply for 7846/RGB

Order Code	Light Colour	CCT (K)	Watts	Lumen (lm)	Input	Class	Box	Notes
<b>7830/RGB</b>	RGB	-	14,4W/m	-	24V DC	II	40	Requires 24V DC driver
<b>7830/RGBW</b>	RGB + Warm white	RGB + 3000K	RGB 14,4W/m + WW 4,8W/m	408lm/m (3000K)	24V DC	II	40	Requires 24V DC driver
<b>7846/RGB</b>	RGB	-	15W/m	-	24V DC	II	50	Requires 24V DC driver

# The Outdoor RGB & RGBW Strip 24V



RGB

IP68

**7830W/RGB** | 14,4W/m | SMD 5050 | 60LEDs/m | Silicone

Supplied in 5m roll / 3M Double face adhesive.



**LED BUILT IN** DIMMABLE **CE**

3 YEAR



Dimming remote control.  
Order code 20034.



DALI & Push to DIM controller.  
Order code 89100LP.



Cut every 10cm (6-LED segment)

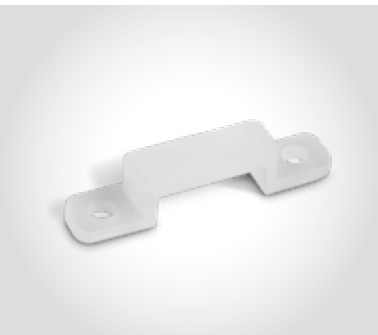

**7827** | Mounting clip for 7830W



RGB+W

IP68

**7830W/RGBW** | 19,2W/m | SMD 5050 | 60LEDs/m | Silicone

Supplied in 5m roll / 3M Double face adhesive.



**LED BUILT IN** DIMMABLE **CE**

3 YEAR

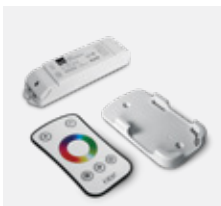

Dimming remote control.  
Order code 20036.



DALI & Push to DIM controller.  
Order code 89100LP.



Cut every 10cm (6-LED segment)



**7827A** | Mounting clip for 7830W/RGBW



Order Code	Light Colour	CCT (K)	Watts	Lumen (lm)	Input	Class	⊠	Notes
<b>7830W/RGB</b>	RGB	-	14,4W/m	-	24V DC	⊠	40	Requires 24V DC driver / Avoid direct sunlight
<b>7830W/RGBW</b>	RGB + Warm white	RGB + 3000K	RGB 14,4W/m + WW 4,8W/m	367lm/m (3000K)	24V DC	⊠	40	Requires 24V DC driver / Avoid direct sunlight



## The Dark Light Profiles



**7903/W** | 2m Surface profile + PC opal diffuser | Aluminium | Suitable for 7820, 7829, 7829A, 7839 & 7843 LED Strips 12mm



DARK LIGHT

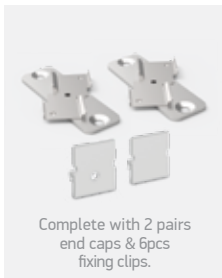

Complete with 2 pairs end caps & 6pcs fixing clips.

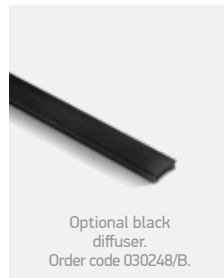

Optional black diffuser.  
Order code 030248/B.

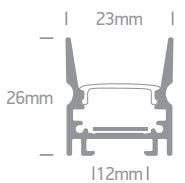

**7903/B** | 2m Surface profile + PC opal diffuser | Aluminium | Suitable for 7820, 7829, 7829A, 7839 & 7843 LED Strips 12mm



DARK LIGHT

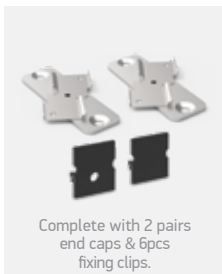

Complete with 2 pairs end caps & 6pcs fixing clips.

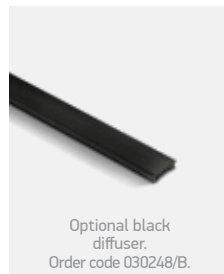

Optional black diffuser.  
Order code 030248/B.

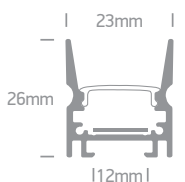

# The Dark Light Profiles



**7903R/W** | 2m Recessed profile + PC opal diffuser | Aluminium | Suitable for 7820, 7829, 7829A, 7839 & 7843 LED Strips 12mm

DARK LIGHT

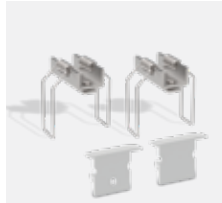

Complete with 2 pairs end caps & 6pcs fixing clips.



Optional black diffuser.  
Order code 030248/B.

24x2000mm

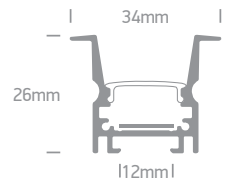

**7903R/B** | 2m Recessed profile + PC opal diffuser | Aluminium | Suitable for 7820, 7829, 7829A, 7839 & 7843 LED Strips 12mm

DARK LIGHT



Complete with 2 pairs end caps & 6pcs fixing clips.



Optional black diffuser.  
Order code 030248/B.

24x2000mm

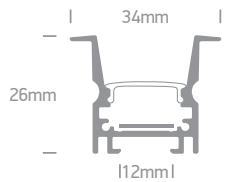

**7903TR/W** | 2m Trimless profile + PC opal diffuser | Aluminium | Suitable for 7820, 7829, 7829A, 7839 & 7843 LED Strips 12mm

DARK LIGHT



Complete with 2 pairs end caps.



Optional black diffuser.  
Order code 030248/B.

24x2000mm

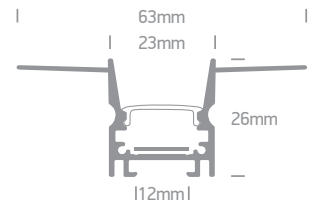

**7903TR/B** | 2m Trimless profile + PC opal diffuser | Aluminium | Suitable for 7820, 7829, 7829A, 7839 & 7843 LED Strips 12mm

DARK LIGHT



Complete with 2 pairs end caps.



Optional black diffuser.  
Order code 030248/B.

24x2000mm

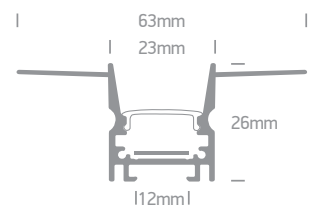



# The Black Profiles Series

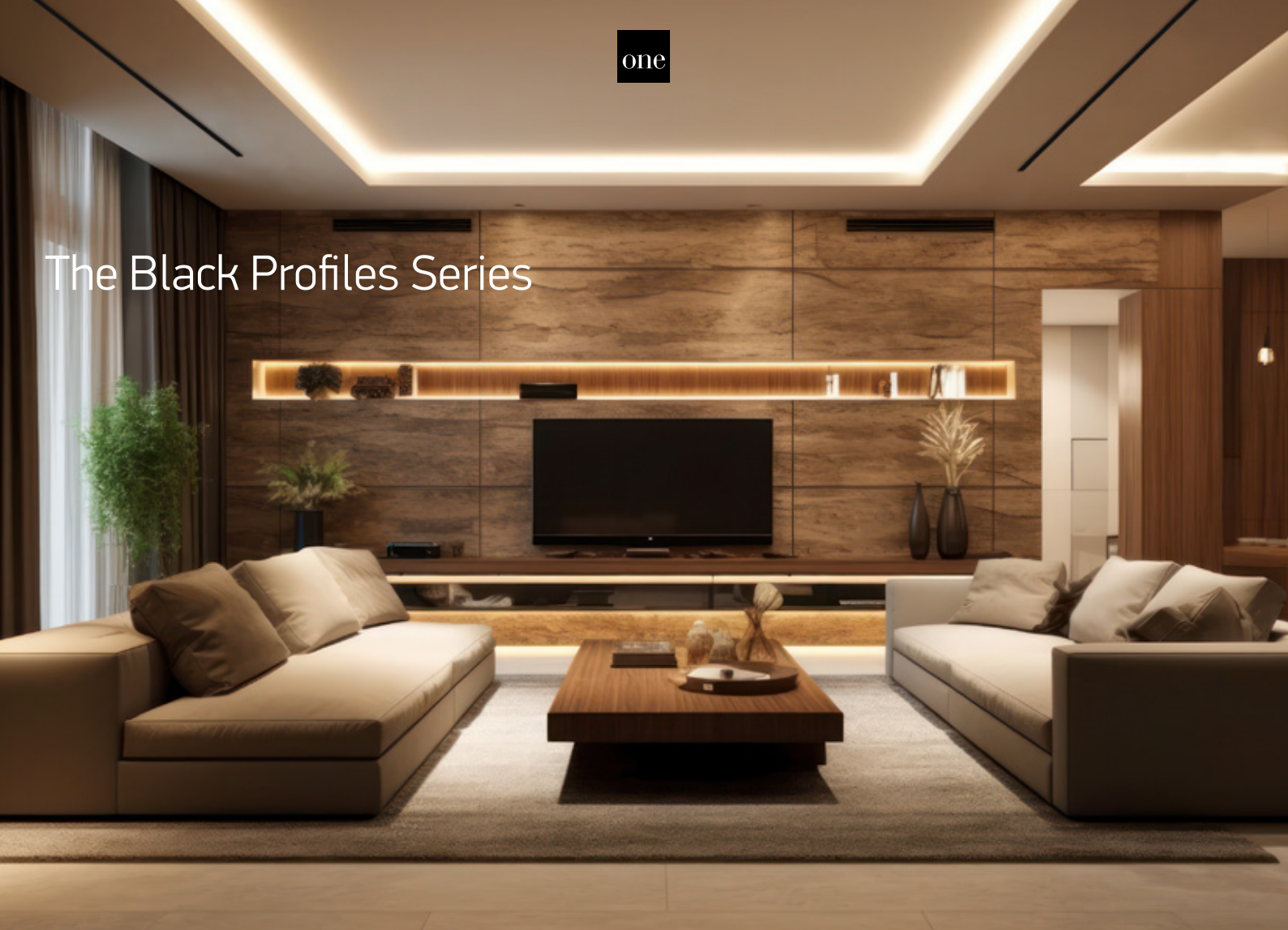

**7902/B/B** | 2m Surface profile + PC black diffuser | Aluminium | Suitable for 7820, 7839, 7843, 7844 & 7844E LED Strip 12mm

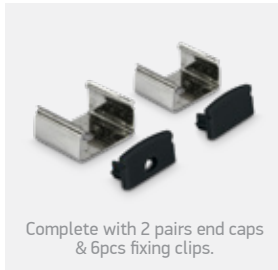

Complete with 2 pairs end caps & 6pcs fixing clips.

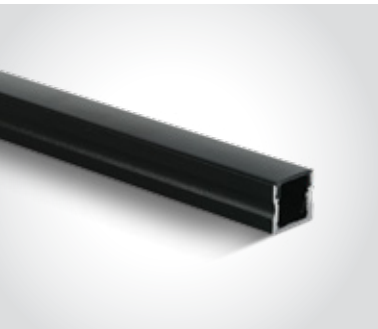
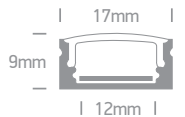

**7904/B/B** | 2m Surface profile + PC black diffuser | Aluminium  
Suitable for 7820, 7829, 7829A, 7835, 7839, 7844, 7844E & 7846 LED Strips 12mm



Complete with 2 pairs end caps & 6pcs fixing clips.

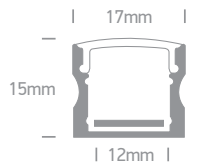

**7912/B/B** | 2m Surface / Suspended profile + PC black diffuser | Aluminium  
Suitable for 7835, 7845, 7846, 7875, 7880, 7882 & 7887 LED Strips 25mm



Complete with 2 pairs end caps.



Optional Trimless kit (10pcs).  
Order code 7838M.



Optional suspension wire (1pc).  
Order code 7900P.



Optional 180° connector.  
Order code 7900C.

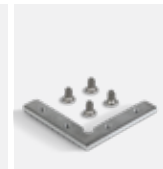

Optional 90° connector.  
Order code 7900R.

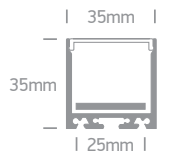

# The Black Profiles Series



7912R/B/B

7901TR/B

**7902R/B/B** | 2m Recessed profile + PC black diffuser | Aluminium | Suitable for 7820, 7839, 7843, 7844 & 7844E LED Strip 12mm

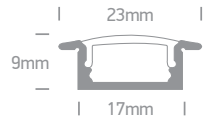
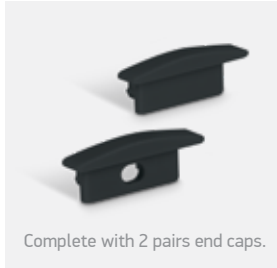
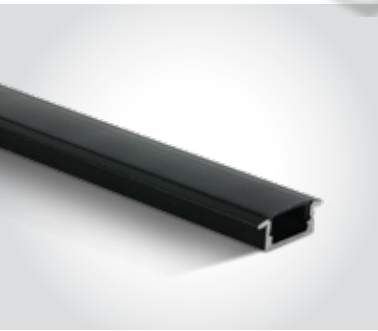

**7912R/B/B** | 2m Recessed profile + PC black diffuser | Aluminium  
Suitable for 7835, 7845, 7846, 7875, 7880 & 7887 LED Strips 20mm

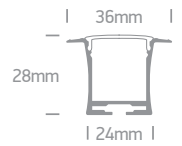
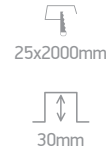

**7910R/B/B** | 2m Recessed profile + PC black diffuser | Aluminium  
Suitable for 7835, 7845, 7846, 7875, 7880, 7882, 7884 & 7887 LED Strips 30mm

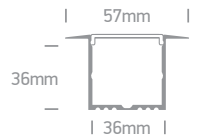

**7901TR/B** | 2m Trimless profile + PC black diffuser | Aluminium  
Suitable for 7820, 7823, 7829, 7829A, 7839, 7843, 7843E, 7844 & 7844E LED Strips 10mm

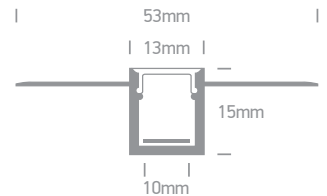
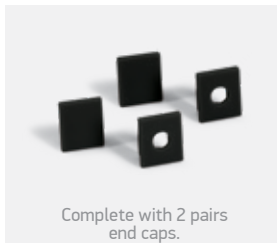

**7904TR/B** | 2m Trimless profile + PC black diffuser | Aluminium  
Suitable for 7820, 7829, 7829A, 7835, 7839, 7846 & 7875 LED Strips 20mm

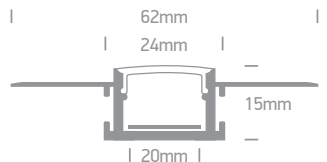
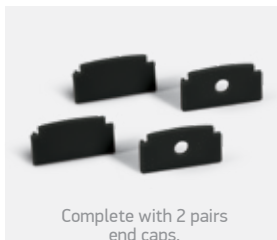

# Surface Slim Profiles



**7900/AL** | 2m Profile for heat dissipation | Aluminium | Suitable for LED Strips up to 12mm



**7901** | 2m Surface profile + PC opal diffuser | Aluminium | Suitable for 7823, 7833 & 7843 LED Strips 5mm

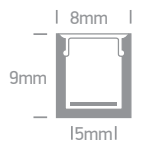
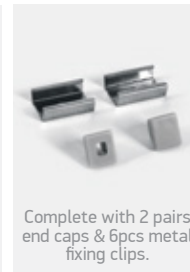

7901/W

7901/B

7901/AL

Complete with 2 pairs end caps & 6pcs metal fixing clips.



**7902** | 2m Surface profile + PC opal diffuser | Aluminium | Suitable for 7820, 7839, 7843, 7844 & 7844E LED Strip 12mm

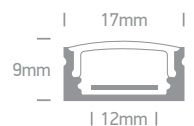

7902/W

7902/B

7902/AL

Complete with 2 pairs end caps & 6pcs metal fixing clips.



## Surface Profiles



7904/W

**7904** | 2m Surface profile + PC opal diffuser | Aluminium  
Suitable for 7820, 7829, 7829A, 7835, 7839, 7844, 7844E & 7846 LED Strips 12mm



7904/B



7904/AL



Complete with 2 pairs end caps & 6pcs fixing clips.

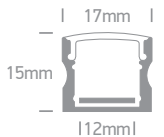

7905/W

**7905** | 2m Surface profile + PC opal diffuser | Aluminium | Suitable for 7835, 7844, 7844E, 7846 & 7875 LED Strips 16mm



7905/B



7905/AL



Complete with 2 pairs end caps & 6pcs fixing clips.

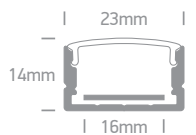



# Surface/Suspended Wide Profiles

## External driver



**7912/W** | 2m Surface/Suspended profile + PC opal diffuser | Aluminium  
Suitable for 7835, 7845, 7846, 7875, 7880, 7882 & 7887 LED Strips 25mm



Complete with 2 pairs end caps.

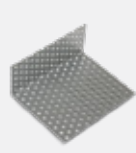

Optional Trimless kit (10pcs).  
Order code 7838M.



Optional suspension wire (1pc).  
Order code 7900P.

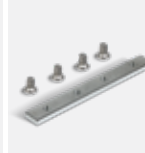

Optional 180° connector.  
Order code 7900C.



Optional 90° connector.  
Order code 7900R.

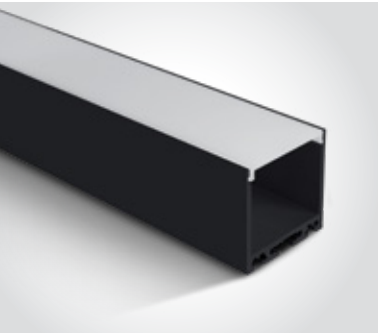
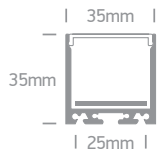

**7912/B** | 2m Surface/Suspended profile + PC opal diffuser | Aluminium  
Suitable for 7835, 7845, 7846, 7875, 7880, 7882 & 7887 LED Strips 25mm

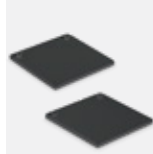

Complete with 2 pairs end caps.

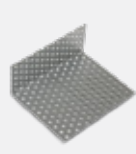

Optional Trimless kit (10pcs).  
Order code 7838M.



Optional suspension wire (1pc).  
Order code 7900P.



Optional 180° connector.  
Order code 7900C.



Optional 90° connector.  
Order code 7900R.

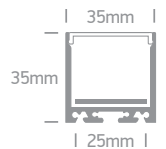

**7912/AL** | 2m Surface / Suspended profile + PC opal diffuser | Aluminium  
Suitable for 7835, 7845, 7846, 7875, 7880, 7882 & 7887 LED Strips 25mm



Complete with 2 pairs end caps.

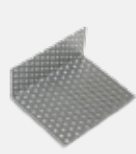

Optional Trimless kit (10pcs).  
Order code 7838M.



Optional suspension wire (1pc).  
Order code 7900P.



Optional 180° connector.  
Order code 7900C.



Optional 90° connector.  
Order code 7900R.

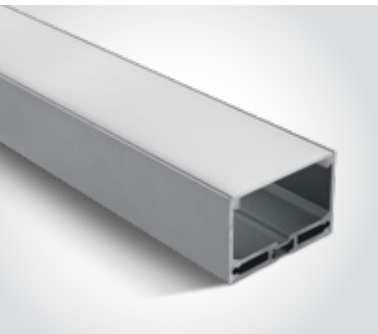
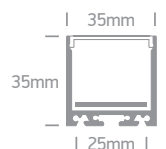

**7912A/AL** | 2m Surface / Suspended profile + PC opal diffuser | Aluminium  
Suitable for 7880, 7884 & 7885 LED Strips 40mm



Complete with 2 pairs end caps.

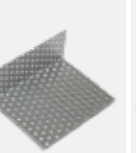

Optional Trimless kit (10pcs).  
Order code 7838M.

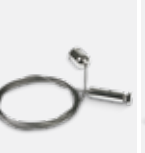

Optional suspension wire (1pc).  
Order code 7900P.



Optional 180° connector.  
Order code 7900C.



Optional 90° connector.  
Order code 7900R.

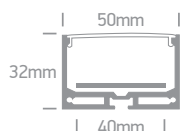



## Surface/Suspended Wide Profiles Internal driver

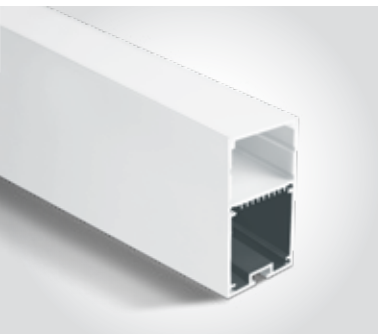

**7910/W** | 2m Surface / Suspended profile + PC opal diffuser | Aluminium  
Suitable for 7845, 7875, 7880, 7882, 7884 & 7887 LED Strips 30mm | Use drivers on pages 755, 756 & 757



Complete with 2 pairs end caps.

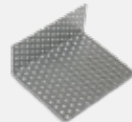

Optional Trimless kit (10pcs).  
Order code 7838M.



Optional suspension wire (1pc).  
Order code 7900P.



Optional 180° connector.  
Order code 7900C.



Optional 90° connector.  
Order code 7900R.

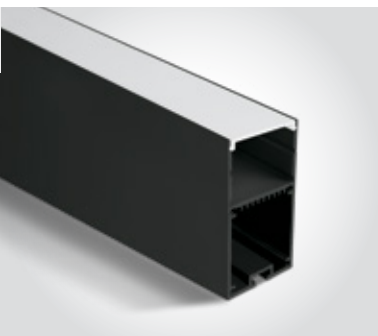
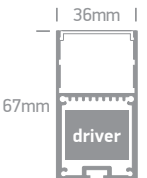

**7910/B** | 2m Surface / Suspended profile + PC opal diffuser | Aluminium  
Suitable for 7845, 7875, 7880, 7882, 7884 & 7887 LED Strips 30mm | Use drivers on pages 755, 756 & 757



Complete with 2 pairs end caps.

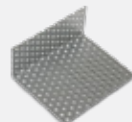

Optional Trimless kit (10pcs).  
Order code 7838M.



Optional suspension wire (1pc).  
Order code 7900P.



Optional 180° connector.  
Order code 7900C.



Optional 90° connector.  
Order code 7900R.

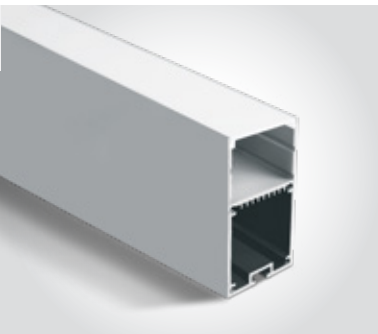
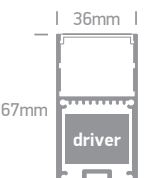

**7910/AL** | 2m Surface / Suspended profile + PC opal diffuser | Aluminium  
Suitable for 7845, 7875, 7880, 7882, 7884 & 7887 LED Strips 30mm | Use drivers on pages 755, 756 & 757

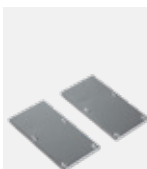

Complete with 2 pairs end caps.

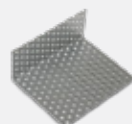

Optional Trimless kit (10pcs).  
Order code 7838M.



Optional suspension wire (1pc).  
Order code 7900P.



Optional 180° connector.  
Order code 7900C.



Optional 90° connector.  
Order code 7900R.

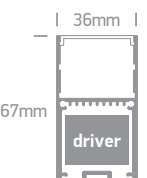



7910A/B

7910A/AL

7910A/W

# Surface/Suspended Wide Profiles

## Internal driver

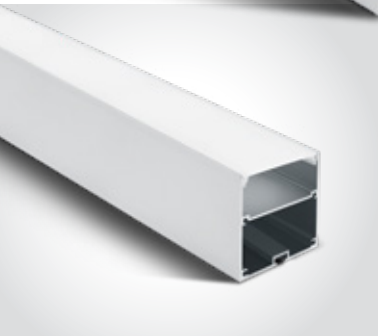

**7910A/W** | 2m Surface / Suspended profile + PC opal diffuser | Aluminium  
 Suitable for 7884 & 7885 LED Strips 45mm | Use drivers on pages 755, 756 & 757



Complete with 2 pairs end caps.



Optional suspension wire (1pc).  
Order code 7900P.



Optional 180° connector.  
Order code 7900C.



Optional 90° connector.  
Order code 7900R.

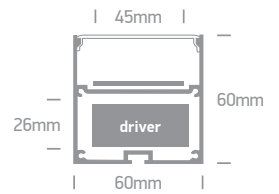

**7910A/B** | 2m Surface / Suspended profile + PC opal diffuser | Aluminium  
 Suitable for 7884 & 7885 LED Strips 45mm | Use drivers on pages 755, 756 & 757



Complete with 2 pairs end caps.



Optional suspension wire (1pc).  
Order code 7900P.



Optional 180° connector.  
Order code 7900C.



Optional 90° connector.  
Order code 7900R.

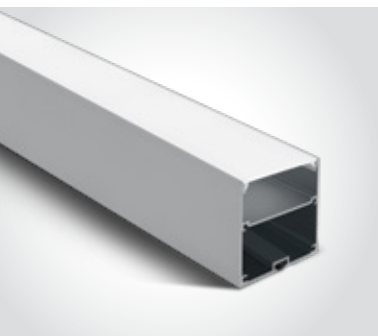
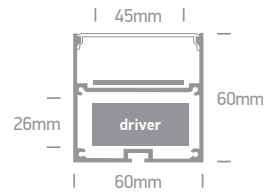

**7910A/AL** | 2m Surface / Suspended profile + PC opal diffuser | Aluminium  
 Suitable for 7884 & 7885 LED Strips 45mm | Use drivers on pages 755, 756 & 757



Complete with 2 pairs end caps.



Optional suspension wire (1pc).  
Order code 7900P.



Optional 180° connector.  
Order code 7900C.



Optional 90° connector.  
Order code 7900R.

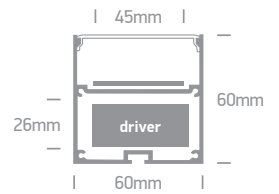

050122/W

White

IP20

**050122** | Profile power supply base | With power cable | Aluminium

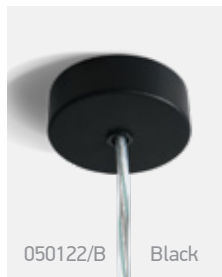

050122/B

Black



050122/G

Grey





## Side Light Surface & Suspended Profiles



**7906/AL** | 2m Surface profile + PMMA opal square diffuser | Aluminium  
 Suitable for 7820, 7825, 7829, 7829A, 7835, 7839, 7844, 7844E, 7846 & 7870 LED Strips 15mm



Complete with 2 pairs end caps.

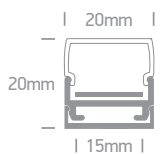

**7906D/AL** | 2m Surface / Suspended profile + PC opal diffuser | Aluminium  
 Suitable for 7880, 7884 & 7885 LED Strips 40mm | Use drivers on pages 755, 756 & 757

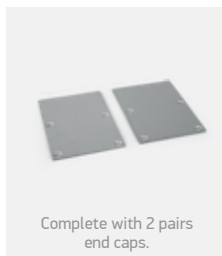

Complete with 2 pairs end caps.

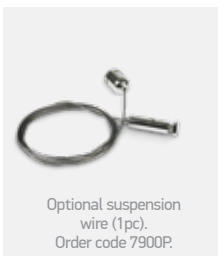

Optional suspension wire (1pc).  
 Order code 7900P.

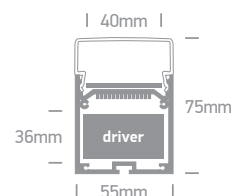



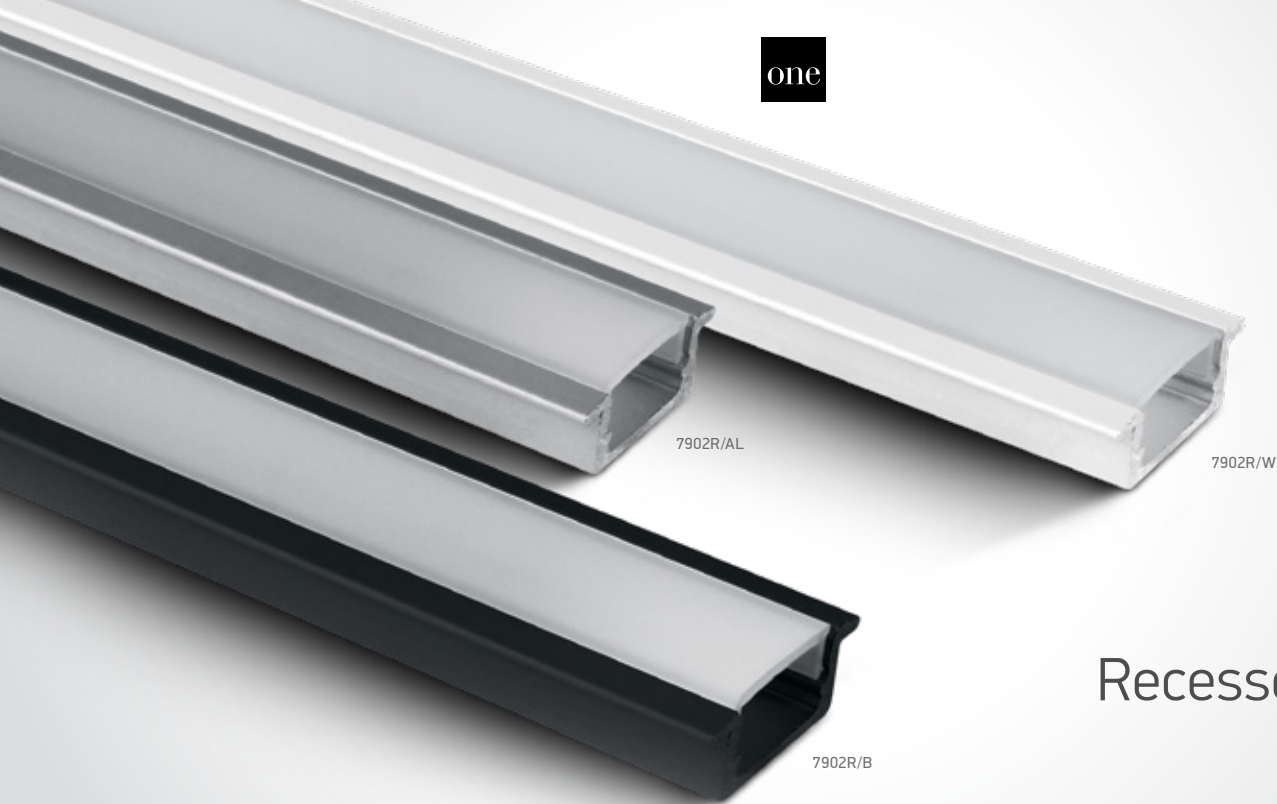

# Recessed Profiles

**7901R/AL** | 2m Recessed profile + PC opal diffuser | Aluminium | Suitable for 7823, 7833, 7843 & 7843E LED Strips 5mm

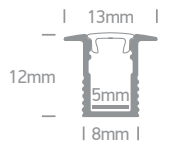
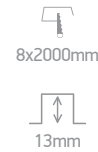

**7902R/W** | 2m Recessed profile + PC opal diffuser | Aluminium | Suitable for 7820, 7839, 7843, 7844 & 7844E LED Strip 12mm

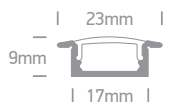

**7902R/B** | 2m Recessed profile + PC opal diffuser | Aluminium | Suitable for 7820, 7839, 7843, 7844 & 7844E LED Strip 12mm

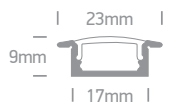
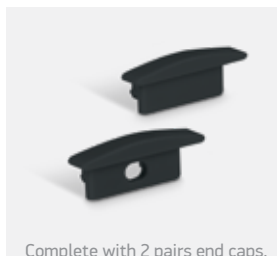

**7902R/AL** | 2m Recessed profile + PC opal diffuser | Aluminium | Suitable for 7820, 7839, 7843, 7844 & 7844E LED Strip 12mm



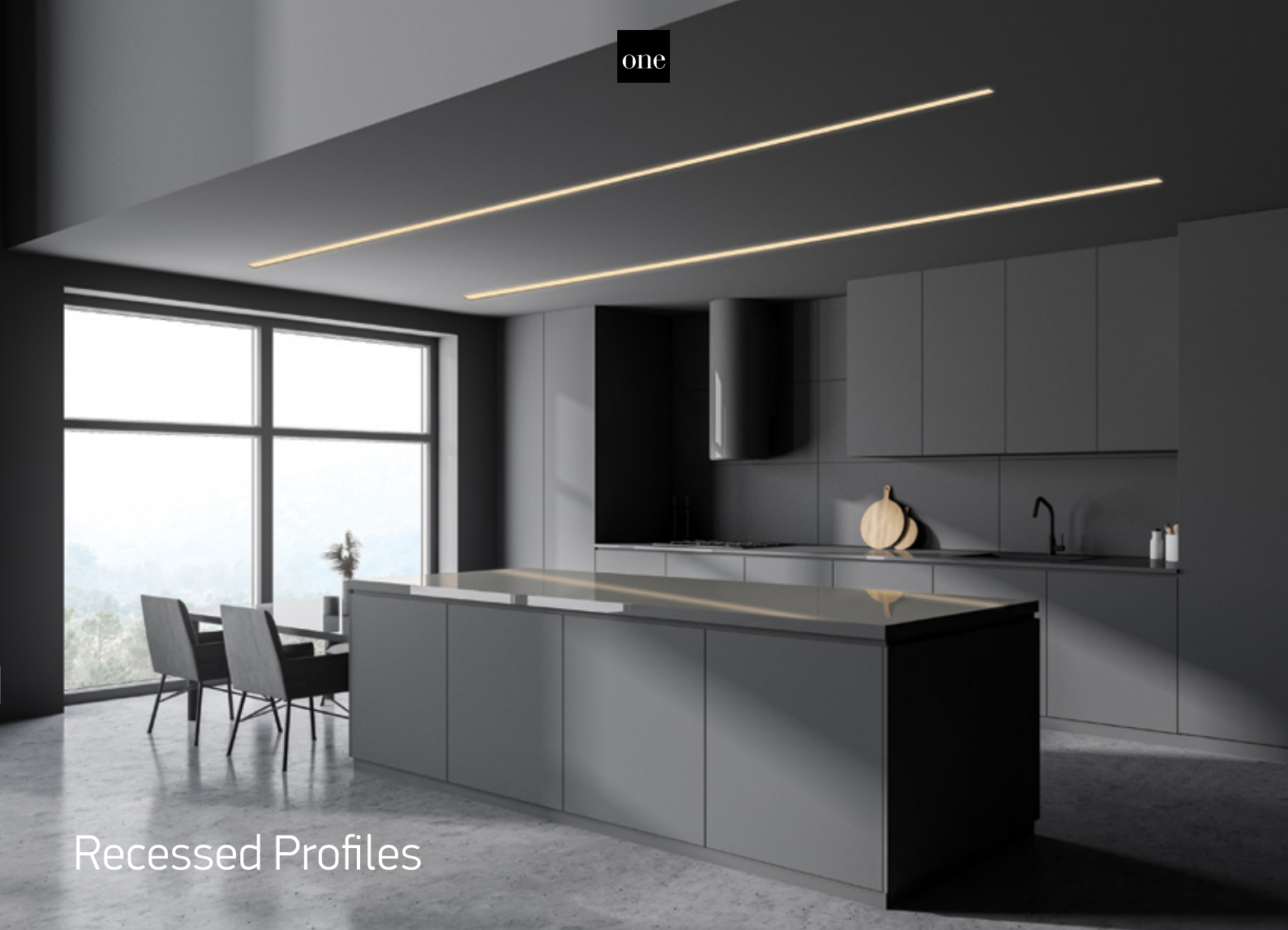

## Recessed Profiles



**7904R/W** | 2m Recessed profile + PC opal diffuser | Aluminium  
Suitable for 7820, 7829, 7829A, 7835, 7839, 7844, 7844E & 7846 LED Strips 12mm

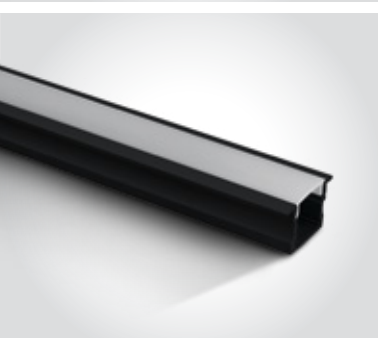
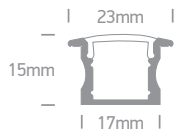
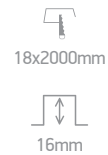

**7904R/B** | 2m Recessed profile + PC opal diffuser | Aluminium  
Suitable for 7820, 7829, 7829A, 7835, 7839, 7844, 7844E & 7846 LED Strips 12mm

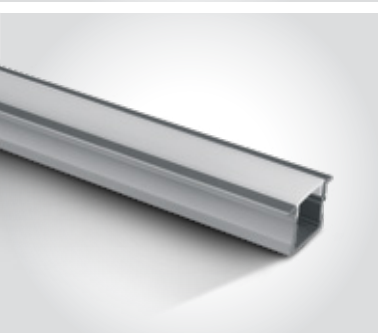
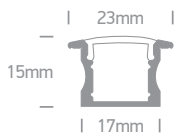

**7904R/AL** | 2m Recessed profile + PC opal diffuser | Aluminium  
Suitable for 7820, 7829, 7829A, 7835, 7839, 7844, 7844E & 7846 LED Strips 12mm

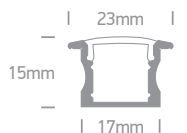

# Recessed Profiles



7912R/AL

7910R/AL

**7906R/W** | 2m Recessed profile + PC opal diffuser | Aluminium  
Suitable for 7820, 7829, 7829A, 7835, 7839, 7844, 7844E & 7846 LED Strips 20mm

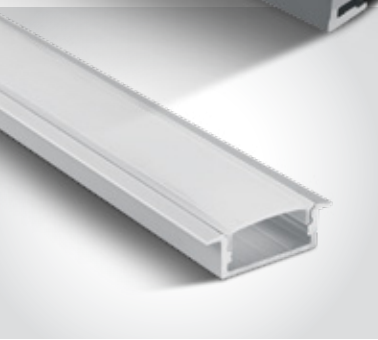
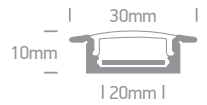

**7906R/AL** | 2m Recessed profile + PC opal diffuser | Aluminium  
Suitable for 7820, 7829, 7829A, 7835, 7839, 7844, 7844E & 7846 LED Strips 20mm

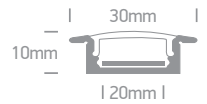
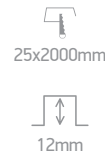

**7912R/W** | 2m Recessed profile + PC opal diffuser | Aluminium  
Suitable for 7835, 7845, 7846, 7875, 7880 & 7887 LED Strips 20mm

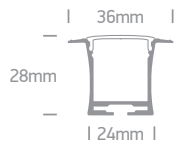
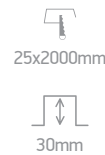

**7912R/B** | 2m Recessed profile + PC opal diffuser | Aluminium  
Suitable for 7835, 7845, 7846, 7875, 7880 & 7887 LED Strips 20mm

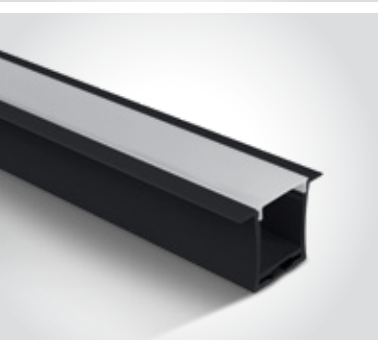
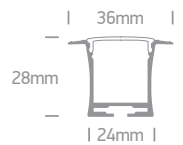
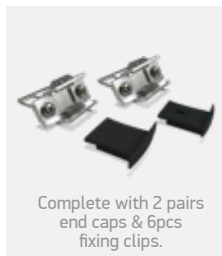

**7912R/AL** | 2m Recessed profile + PC opal diffuser | Aluminium  
Suitable for 7835, 7845, 7846, 7875, 7880 & 7887 LED Strips 20mm

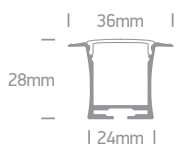

# Recessed Profiles

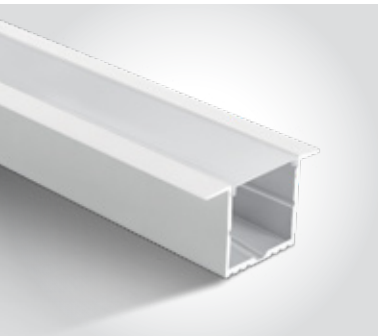

**7910R/W** | 2m Recessed profile + PC opal diffuser | Aluminium  
Suitable for 7835, 7845, 7846, 7875, 7880, 7882, 7884 & 7887 LED Strips 30mm

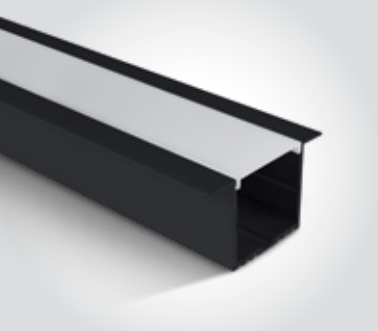
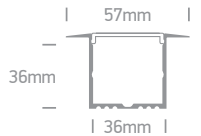
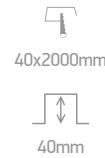

**7910R/B** | 2m Recessed profile + PC opal diffuser | Aluminium  
Suitable for 7835, 7845, 7846, 7875, 7880, 7882, 7884 & 7887 LED Strips 30mm

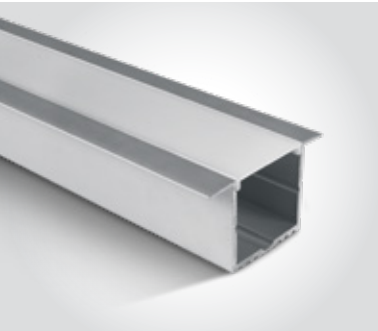
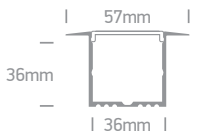
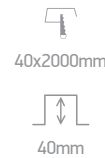

**7910R/AL** | 2m Recessed profile + PC opal diffuser | Aluminium  
Suitable for 7835, 7845, 7846, 7875, 7880, 7882, 7884 & 7887 LED Strips 30mm

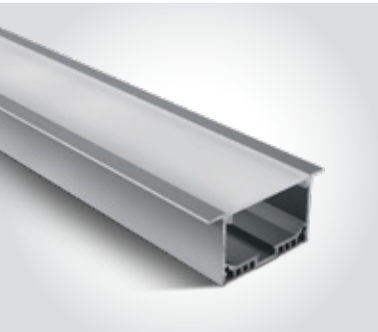
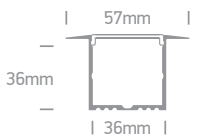

**7910AR/AL** | 2m Recessed profile + PC opal diffuser | Aluminium  
Suitable for 7875, 7880, 7884 & 7885 LED Strips 40mm

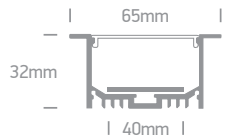

# Trimless Recessed Profiles

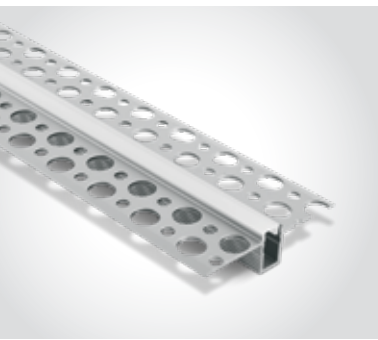

**7900TR/AL** | 2m Trimless profile + PC opal diffuser | Aluminium  
Suitable for 7823, 7843 & 7843E LED Strips 5mm

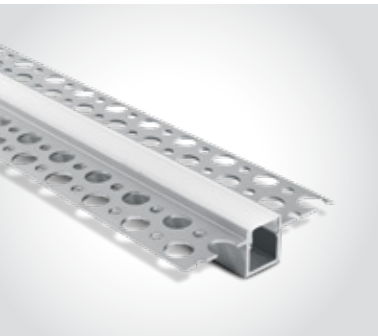
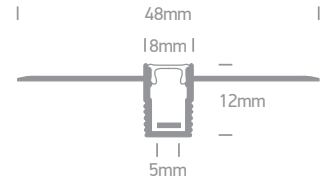
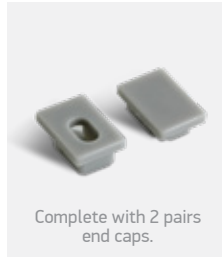

**7901TR/AL** | 2m Trimless profile + PC opal diffuser | Aluminium  
Suitable for 7820, 7823, 7829, 7829A, 7839, 7843, 7843E, 7844 & 7844E LED Strips 10mm

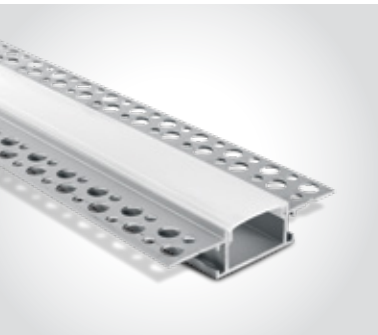
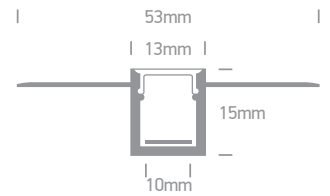
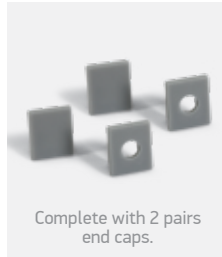

**7904TR/AL** | 2m Trimless profile + PC opal diffuser | Aluminium  
Suitable for 7820, 7829, 7829A, 7835, 7839, 7844, 7844E, 7846 & 7875 LED Strips 20mm

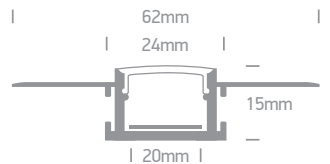

**7906TR/AL** | 2m Trimless profile + PC opal diffuser | Aluminium | Suitable for 7875 & 7880 LED Strips 37mm

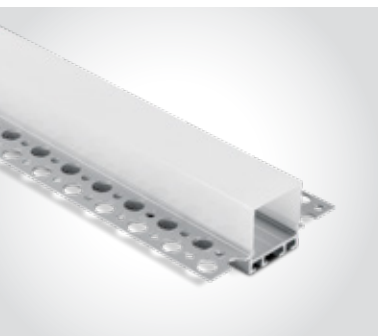
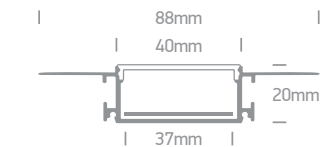
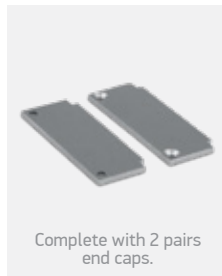

**7904ATR/AL** | 2m Trimless profile + PC opal diffuser | Aluminium  
Suitable for 7820, 7829, 7829A, 7835, 7839, 7844, 7844E, 7845, 7846, 7875 & 7887 LED Strips 20mm

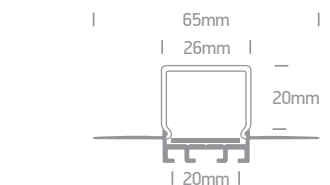
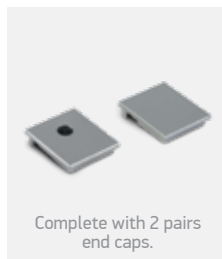



# Trimless Edge Recessed Profiles

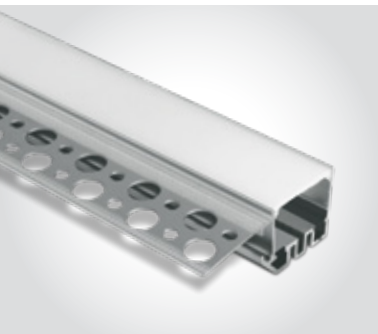

**7909TR/AL** | 2m Trimless profile + PC opal diffuser | Aluminium  
 Suitable for 7820, 7829, 7829A, 7835, 7839, 7844, 7844E, 7846 & 7875 LED Strips 20mm

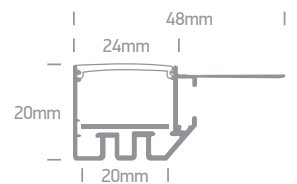
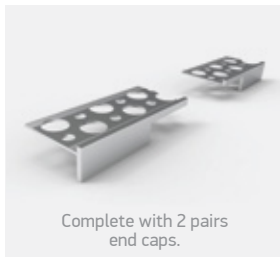



## Triangular Profiles



**7908A/AL** | 2m Triangle profile + PC opal diffuser | Aluminium  
Suitable for 7820, 7829, 7829A, 7835, 7839, 7844, 7844E & 7846 LED Strips 10mm

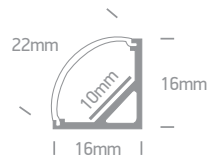

Shelf illumination



**7908/AL** | 2m Triangle profile + PC opal diffuser | Aluminium  
Suitable for 7820, 7829, 7829A, 7835, 7839, 7844, 7844E, 7846 & 7875 LED Strips 16mm

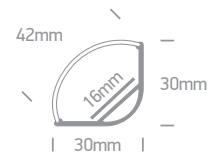

Shelf illumination

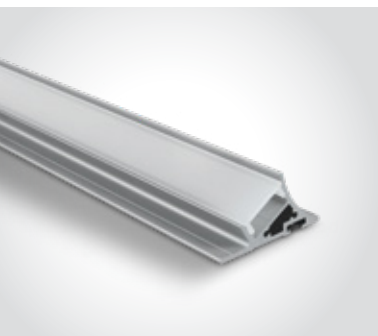

**7937T/AL** | 2m Surface profile + PC semi-opal diffuser | Aluminium  
Suitable for 7820, 7829, 7829A, 7839, 7843, 7844 & 7844E LED Strips 12mm

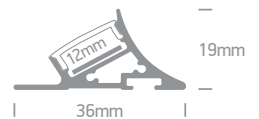

Shelf illumination



## Skirting Profiles



**7922/W** | 2m Wall profile + PC opal diffuser | Aluminium | Suitable for 7820, 7839, 7843, 7844 & 7844E LED Strip 8mm

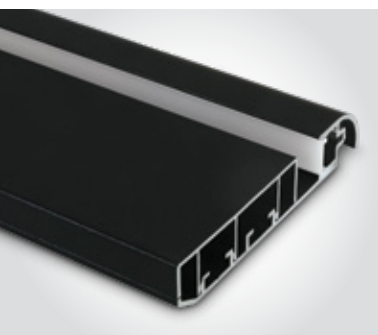
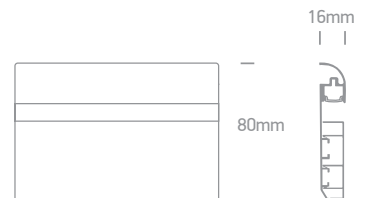

**7922/B** | 2m Wall profile + PC opal diffuser | Aluminium | Suitable for 7820, 7839, 7843, 7844 & 7844E LED Strip 8mm

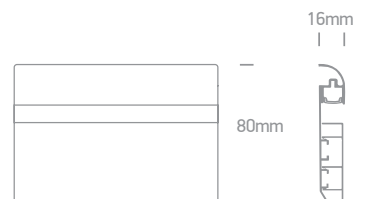





## Special Applications Profiles

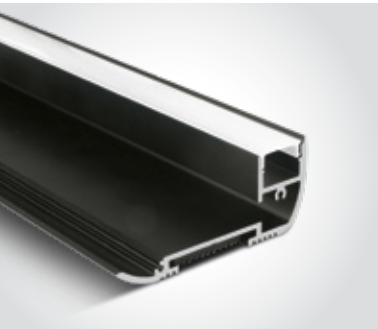

**7920/B** | 2m Step profile + PC opal diffuser | Aluminium | Suitable for 7820, 7839, 7843, 7844 & 7844E LED Strips 8mm

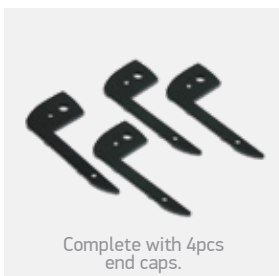

Complete with 4pcs end caps.

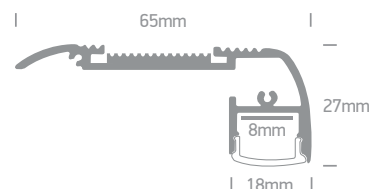



## IP67 & IP68 Profiles



**7918/W** | 2m White profile + PMMA opal diffuser | Plastic  
Suitable for 7820, 7829, 7829A, 7839, 7844 & 7844E LED Strips 8mm



IP68

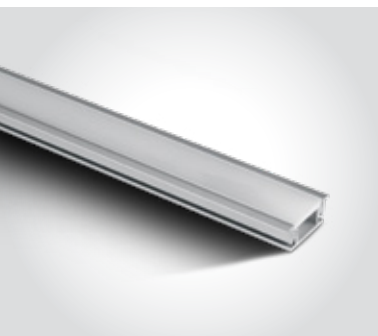
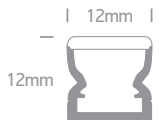

**7914R/AL** | 2m Inground profile + 3mm PC opal diffuser | Aluminium  
Suitable for 7820, 7829, 7829A, 7839, 7843, 7844 & 7844E LED Strips 8mm



IP67



23x2000mm

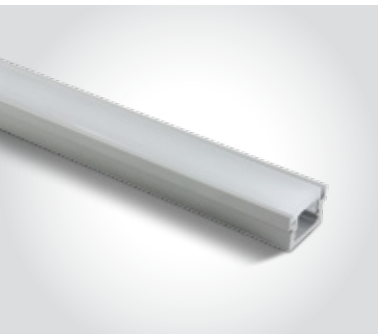
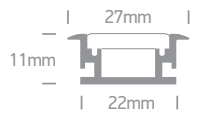

**7915R/AL** | 2m Inground profile + 3mm PC opal diffuser | Aluminium  
Suitable for 7820, 7829, 7829A, 7839, 7843, 7844 & 7844E LED Strips 10mm



IP67



22x2000mm

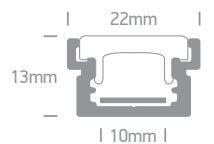



## Modules For Signs



**7840** | 0,72W (3LEDs x 0,24W)

Double face adhesive.



**IP65**  
**offer**

**3**  
YEAR

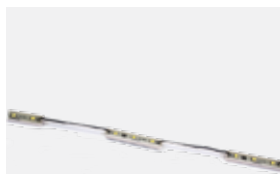

Supplied in 10pcs chain.  
Total length 1,7m.

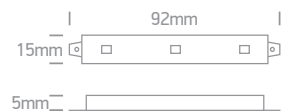

**7842** | 1,44W (4LEDs x 0,36W)

Double face adhesive.



**IP65**  
**offer**

**3**  
YEAR

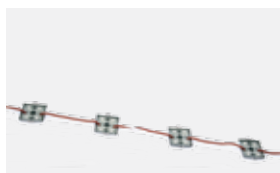

Supplied in 10pcs chain.  
Total length 1,25m.

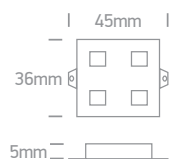

Order Code	Light Colour	CCT (K)	Watts	Lumen (lm)	Input	Class		Notes
7840/Y	Yellow	-	0,72W	-	12V DC		100	Requires 12V DC driver
7842/BL	Blue	-	1,44W	-	12V DC		100	Requires 12V DC driver
7842/GR	Green	-	1,44W	-	12V DC		100	Requires 12V DC driver
7842/Y	Yellow	-	1,44W	-	12V DC		100	Requires 12V DC driver

# Modules for Signs & Backlit Applications

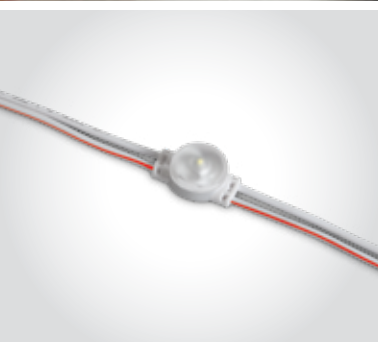

**7840A** | 0,5W | 2,5W/m | SMD 2835 | Plastic

Modules for signs.

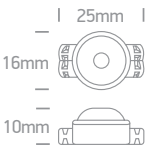
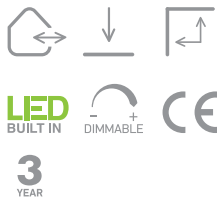

IP65

3 YEAR

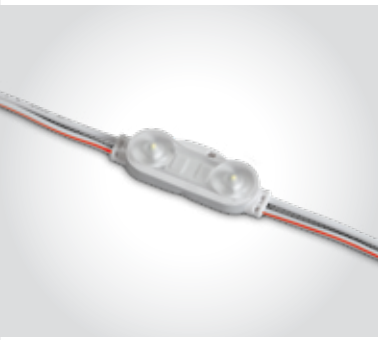

**7840B** | 2x0,5W | 5W/m | SMD 2835 | Plastic

Modules for signs.

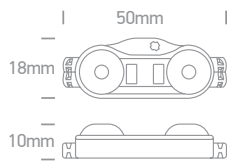

IP65

3 YEAR

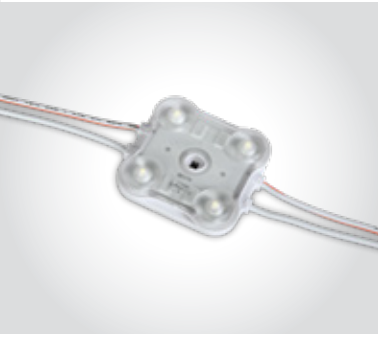

**7840D** | 4x0,5W | 10W/m | SMD 2835 | Plastic

Modules for signs.

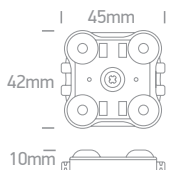

IP65

3 YEAR

Order Code	Light Colour	CCT (K)	Watts	Lumen (lm)	Input	Class	Box	Notes
7840A/D	Daylight	6000K	0,5W	45lm	12V DC	III	50	Requires 12V DC driver
7840B/D	Daylight	6000K	1W	90lm	12V DC	III	30	Requires 12V DC driver
7840D/D	Daylight	6000K	2W	180lm	12V DC	III	20	Requires 12V DC driver

# The 230V Solid LED Strip

## Aluminium + PC



**38104L** | 4W | LED | Aluminium + PC

Connect maximum 5pcs at 110V / Connect maximum 10pcs at 230V.

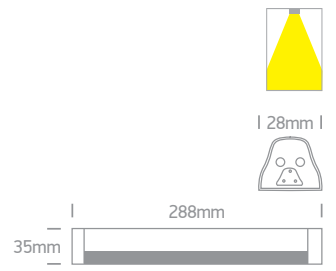
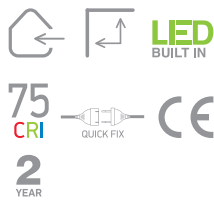

IP20  
**offer**



**38115L** | 15W | LED | Aluminium + PC

Connect maximum 5pcs at 110V / Connect maximum 10pcs at 230V.

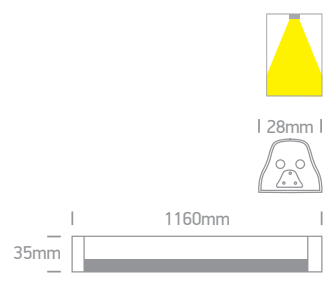

IP20  
**offer**

Order Code	Light Colour	CCT (K)	Watts	Lumen (lm)	Input	Class		Notes
38104L/W	Warm white	3000K	4W	280lm	100-240V		50	Includes power supply cable, corner cable, connector
38115L/C	Cool white	4000K	15W	1095lm	100-240V		30	Includes power supply cable, corner cable, connector



# The 230V Solid Double LED Strip Aluminium + PC

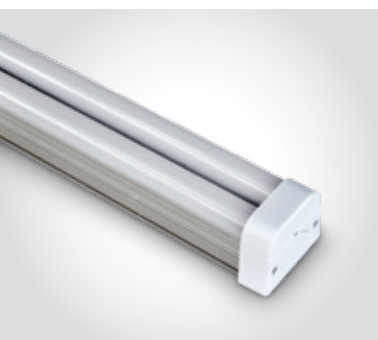

**38207L** | 7W | LED | Aluminium + PC

Connect maximum 5pcs at 110V / Connect maximum 10pcs at 230V.

**75**  
 CRI
 

  
**IP20**  
**offer**
  
**2**  
 YEAR

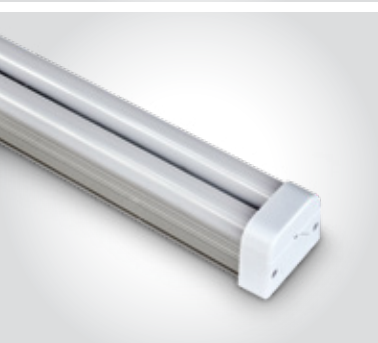
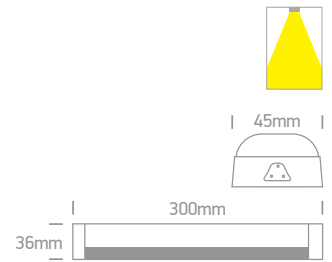

**38215L** | 15W | LED | Aluminium + PC

Connect maximum 5pcs at 110V / Connect maximum 10pcs at 230V.

**75**  
 CRI
 

  
**IP20**  
**offer**
  
**2**  
 YEAR

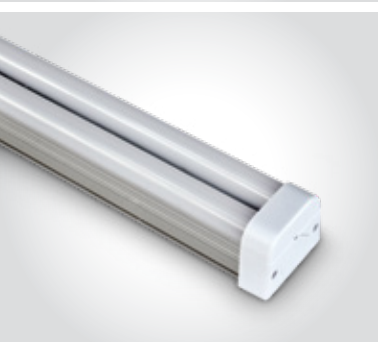
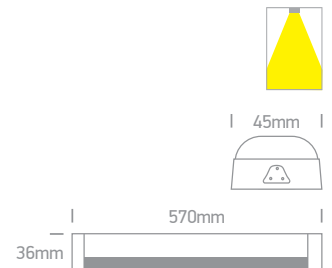

**38230L** | 30W | LED | Aluminium + PC

Connect maximum 5pcs at 110V / Connect maximum 10pcs at 230V.

**75**  
 CRI
 

  
**IP20**  
**offer**
  
**2**  
 YEAR

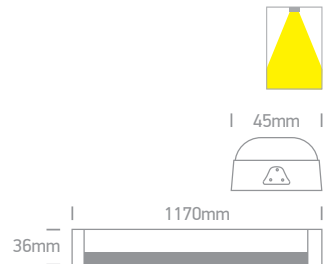

Order Code	Light Colour	CCT (K)	Watts	Lumen (lm)	Input	Class		Notes
38207L/D	Daylight	6000K	7W	530lm	100-240V		30	Includes power supply cable, corner cable, connector
38207L/C	Cool white	4000K	7W	510lm	100-240V		30	Includes power supply cable, corner cable, connector
38207L/W	Warm white	3000K	7W	490lm	100-240V		30	Includes power supply cable, corner cable, connector
38215L/W	Warm white	3000K	15W	1050lm	100-240V		25	Includes power supply cable, corner cable, connector
38230L/W	Warm white	3000K	30W	2100lm	100-240V		20	Includes power supply cable, corner cable, connector

# 24V Linkable Modules Aluminium

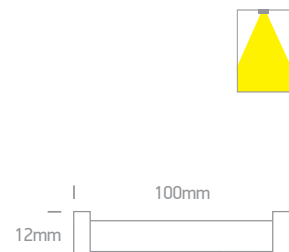

**38001A** | 1W | LED | Aluminium

**38002A** | 3W | LED | Aluminium

**38005A** | 6W | LED | Aluminium

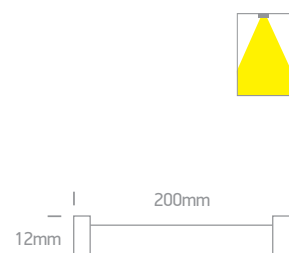
**38006 & 38007** | Power supply cable and corner cable for 38001A, 38002A & 38005A

**Power supply cable**  
 38006A For DL and WW  
 38006B For BL  
 38006C For RGB

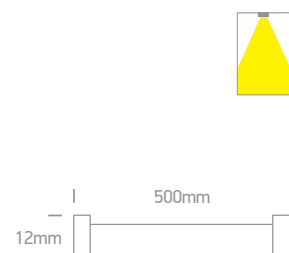
**Corner cable**  
 38007A For DL and WW  
 38007B For BL  
 38007C For RGB





Order Code	Light Colour	CCT (K)	Watts	Lumen (lm)	Input	Class		Notes
38001A/D	Daylight	6000K	1W	64lm	24V DC		100	Requires 24V DC driver
38001A/W	Warm white	3000K	1W	60lm	24V DC		100	Requires 24V DC driver
38001A/BL	Blue	-	1W	-	24V DC		100	Requires 24V DC driver
38001A/RGB	RGB	-	1W	-	24V DC		100	Requires 24V DC driver
38002A/D	Daylight	6000K	3W	144lm	24V DC		100	Requires 24V DC driver
38002A/BL	Blue	-	3W	-	24V DC		100	Requires 24V DC driver
38002A/RGB	RGB	-	3W	-	24V DC		100	Requires 24V DC driver
38005A/D	Daylight	6000K	6W	384lm	24V DC		100	Requires 24V DC driver
38005A/BL	Blue	-	6W	-	24V DC		100	Requires 24V DC driver

# The 230V Solid LED Strip Plastic

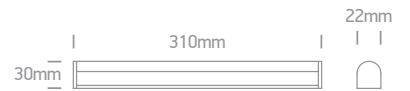
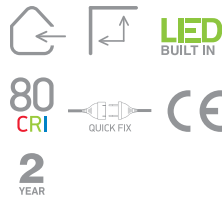

**38104B** | 4W | SMD 2835 | Plastic

Connect 25 fittings maximum.



**38108B** | 8W | SMD 2835 | Plastic

Connect 12 fittings maximum.

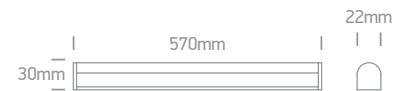
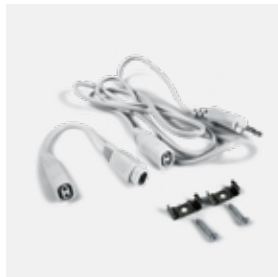
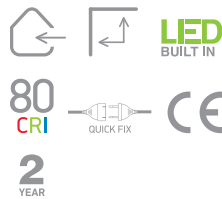

**38114B** | 14W | SMD 2835 | Plastic

Connect 7 fittings maximum.

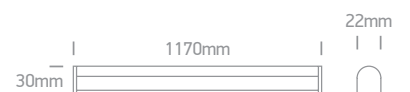
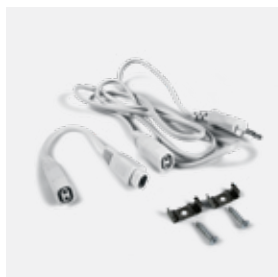
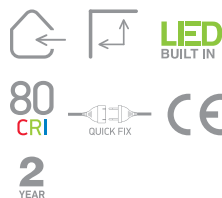

Order Code	Light Colour	CCT (K)	Watts	Lumen (lm)	Input	Class	Box	Notes
38104B/W	Warm white	3000K	4W	440lm	230V	□	30	Complete with driver
38108B/W	Warm white	3000K	8W	880lm	230V	□	30	Complete with driver
38114B/C	Cool white	4000K	14W	1540lm	230V	□	30	Complete with driver
38114B/W	Warm white	3000K	14W	1540lm	230V	□	30	Complete with driver



# The LED Shelf System

## Aluminium + PC



**38103** | 3W | SMD 3014 | Aluminium + PC

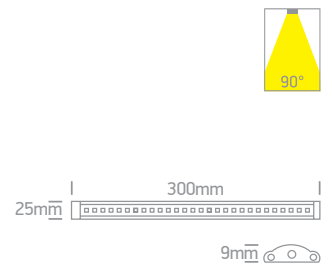
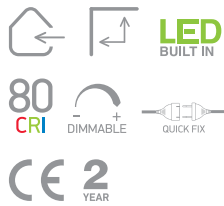

**38105** | 5W | SMD 3014 | Aluminium + PC

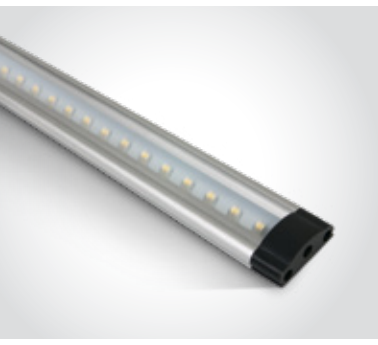
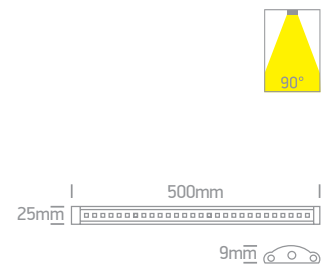
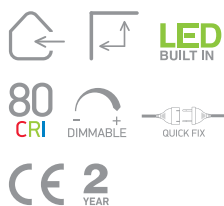

**38110** | 10W | SMD 3014 | Aluminium + PC

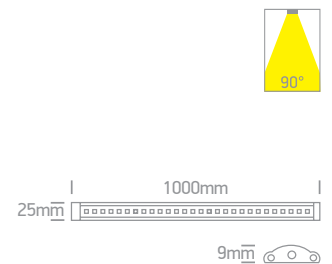
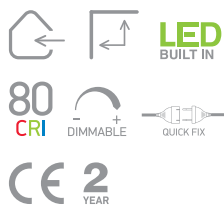

Order Code	Light Colour	CCT (K)	Watts	Lumen (lm)	Input	Class	Box	Notes
38103/W	Warm white	3000K	3W	225lm	24V DC	II	100	Requires 24V DC driver / Includes mounting clips (2pcs), screws (2pcs)
38105/W	Warm white	3000K	5W	375lm	24V DC	II	50	Requires 24V DC driver / Includes mounting clips (2pcs), screws (2pcs)
38110/W	Warm white	3000K	10W	750lm	24V DC	II	25	Requires 24V DC driver / Includes mounting clips (3pcs), screws (3pcs)

# The LED Shelf System Accessories



**38102A** | Touch ON/OFF and dimmer | Max. 60W | 24V DC



IP20

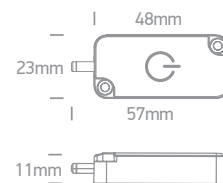

**38102B** | Wave hand | Door ON/OFF | Max. 60W | 24V DC



IP20

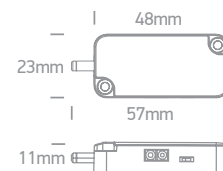

**38102C** | PIR Sensor | Max. 60W | 24V DC

Adjustable 1min / 5min.



IP20

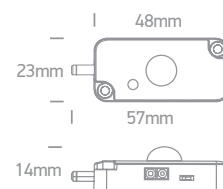

**38101A** | Connector for 38103, 38105 & 38110



IP20

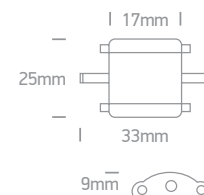

**38101B** | Corner for 38103, 38105 & 38110



IP20

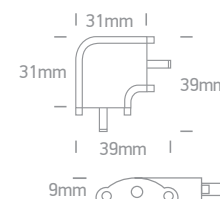

**38101C** | Power supply cable connector for 38103, 38105 & 38110

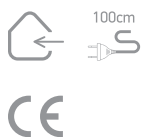

**38101D** | 8 - Way connection box | 24V DC

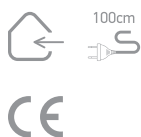

IP20

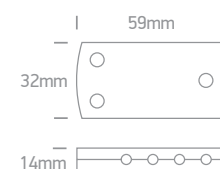

# The 230V IP65 Range



**7850** | 6W/m | SMD 2835 | 60LEDs/m | PVC

Cut every 1m.

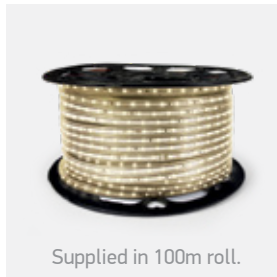
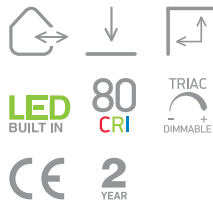

Supplied in 100m roll.



IP65



7850C Connector



7850P  
230V Power supply  
for 100m



7850F Fixing clip



7850L Corner connector

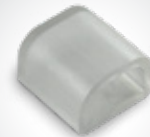

7850E End cap



7860R  
Shrinking sleeve



**7860** | 9W/m | SMD 5730 | 60LEDs/m | PVC

Cut every 1m.

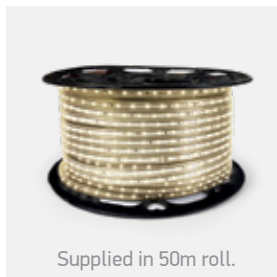
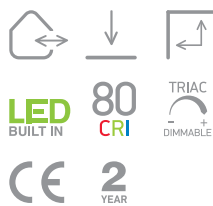

Supplied in 50m roll.



IP65



7860C Connector



7860P  
230V Power supply  
for 50m



7860F Fixing clip

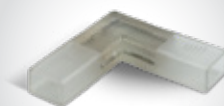

7860L Corner connector



7860E End cap

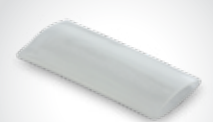

7860R  
Shrinking sleeve

Order Code	Light Colour	CCT (K)	Watts	Lumen (lm)	Input	Class	Box	Notes
7850/W	Warm white	3000K	6W/m	440lm/m	230V	<input type="checkbox"/>	100m roll	Requires 7850P power supply / Avoid direct sunlight
7860/D	Daylight	6000K	9W/m	750lm/m	230V	<input type="checkbox"/>	50m roll	Requires 7860P power supply / Avoid direct sunlight
7860/C	Cool white	4000K	9W/m	750lm/m	230V	<input type="checkbox"/>	50m roll	Requires 7860P power supply / Avoid direct sunlight
7860/W	Warm white	3000K	9W/m	750lm/m	230V	<input type="checkbox"/>	50m roll	Requires 7860P power supply / Avoid direct sunlight



# The 230V IP65 Range

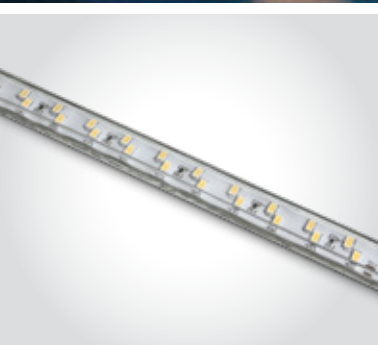

7862 | 13W/m | SMD 5730 | 120LEDs/m | PVC

Cut every 1m.

**LED BUILT IN**
  
**80 CRI**
  
**CE**
  
**2 YEAR**
  
**IP65**

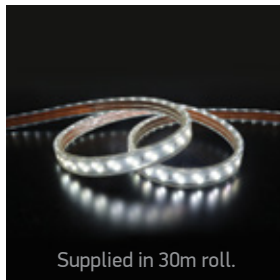

Order Code	Light Colour	CCT (K)	Watts	Lumen (lm)	Input	Class	Package	Notes
7862/C	Cool white	4000K	13W/m	1050lm/m	230V	□	30m roll	Requires 7862P power supply / Avoid direct sunlight
7862/W	Warm white	3000K	13W/m	1000lm/m	230V	□	30m roll	Requires 7862P power supply / Avoid direct sunlight

# 230V Neon Flex Lightline



7864 | 9W/m | SMD 2835 | 120LEDs/m | PVC

Cut every 1m.

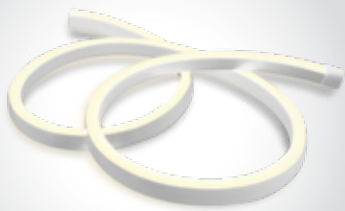

7864/C

IP65

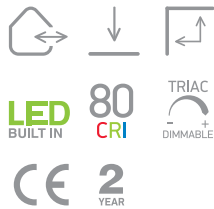

7864/W



8mm

12mm



7864C  
Connector + shrinking sleeve.



7864P  
230V Power supply 50m max.



7864F Fixing clip.



7864E End cap.

Order Code	Light Colour	CCT (K)	Watts	Lumen (lm)	Input	Class		Notes
7864/C	Cool white	4000K	9W/m	270lm/m	230V		50m roll	Requires 7864P power supply / Avoid direct sunlight
7864/W	Warm white	3000K	9W/m	270lm/m	230V		50m roll	Requires 7864P power supply / Avoid direct sunlight

# 230V COB Flex Lightline

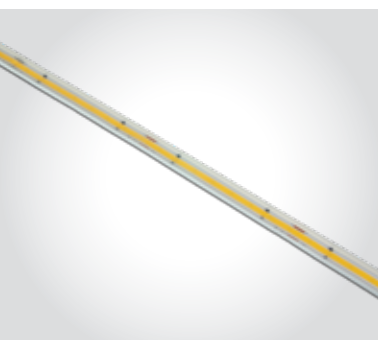
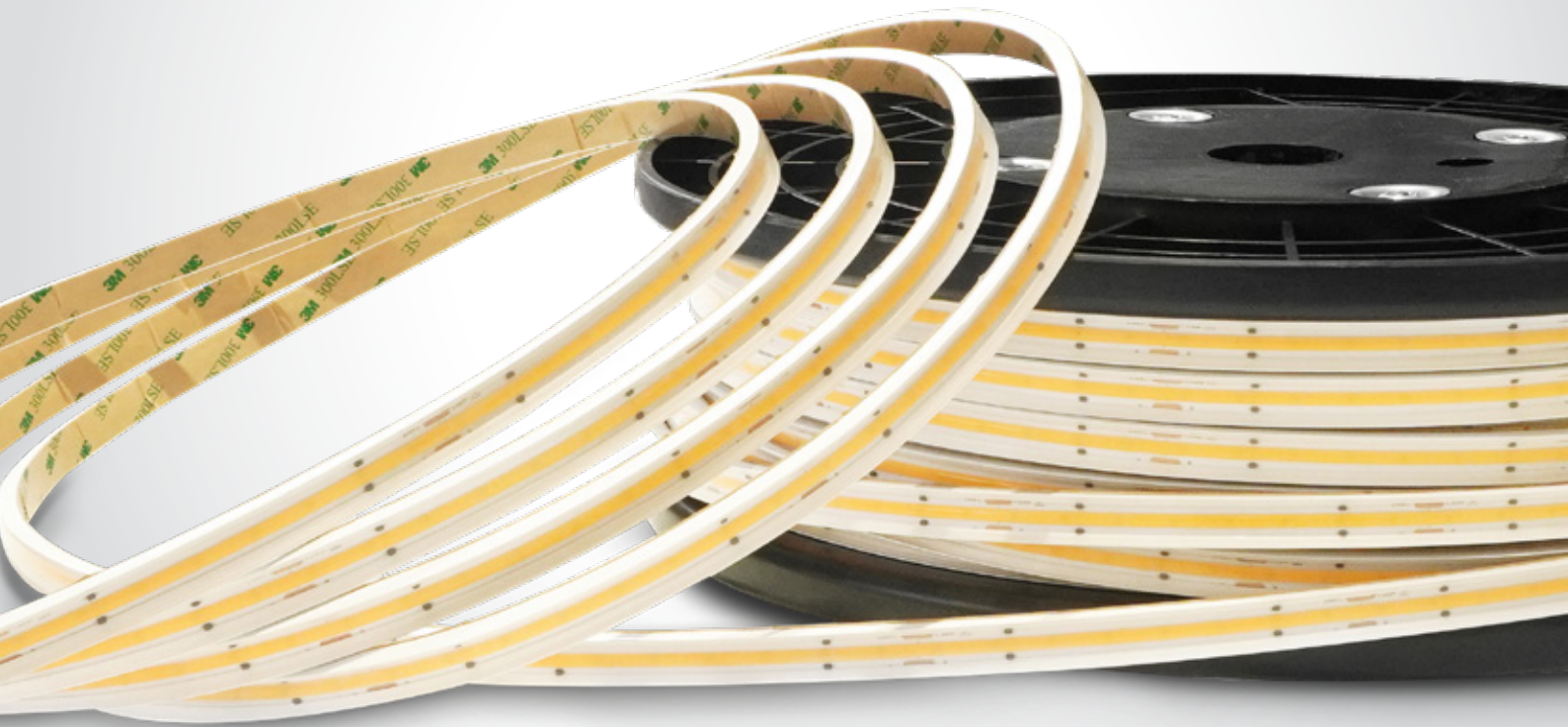

**7872** | 12W/m | COB LED | 480LEDs/m | Silicone

Supplied in 50m roll with 3M double face adhesive.

**LED BUILT IN**
  
**90 CRI**
  
**TRIAC DIMMABLE**
  
**3 YEAR**



**new**  
IP66



Order Code	Light Colour	CCT (K)	Watts	Lumen (lm)	Beam Angle	Input	Class			Notes
<b>7872/C</b>	Cool white	4000K	12W/m	840lm/m	140°	230V		100cm	50m roll	Supplied with power supply EU plug / Avoid direct sunlight
<b>7872/W</b>	Warm white	3000K	12W/m	800lm/m	140°	230V		100cm	50m roll	Supplied with power supply EU plug / Avoid direct sunlight

# Neon Flex Lightlines

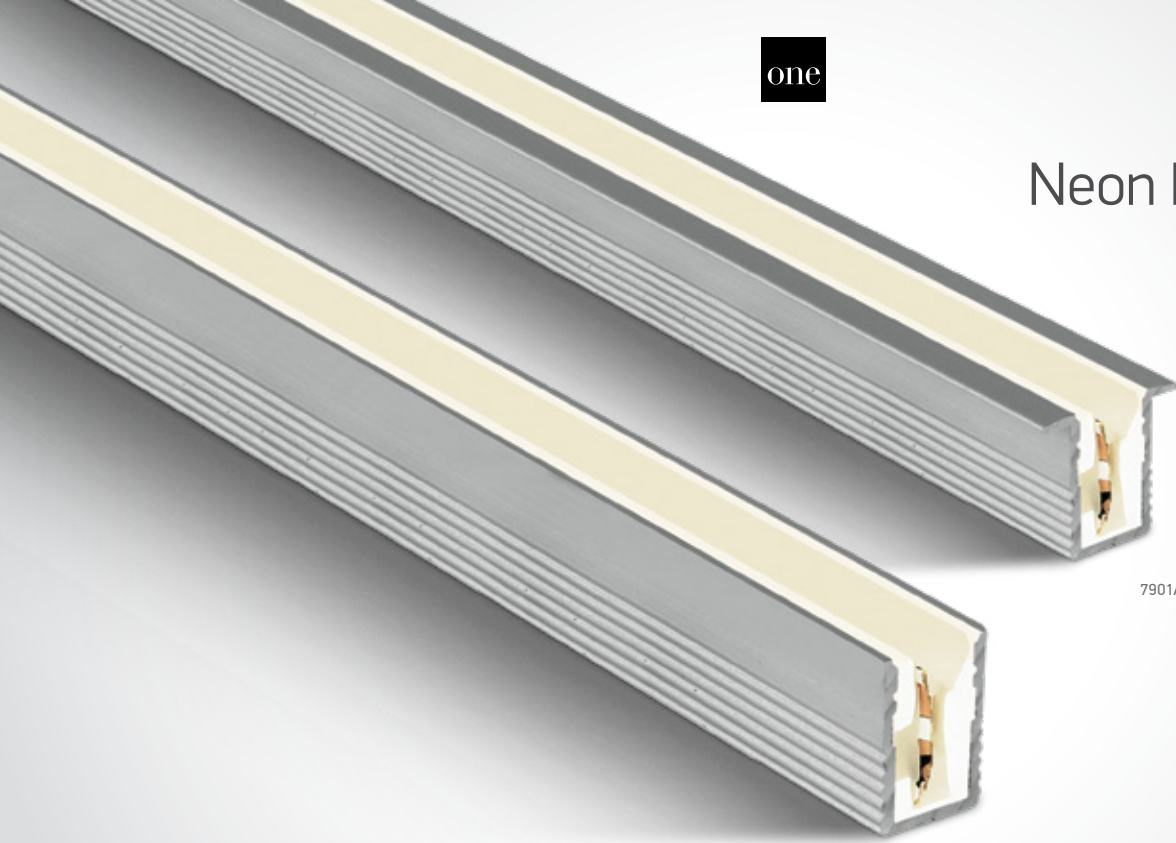

7901AR/AL

7901A/AL

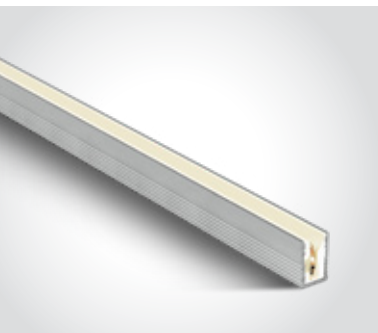

**7901A/AL** | 2m Surface profile | Aluminium | Suitable for 7841 LED Strip

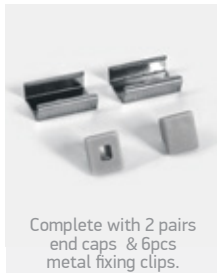

Complete with 2 pairs end caps & 6pcs metal fixing clips.

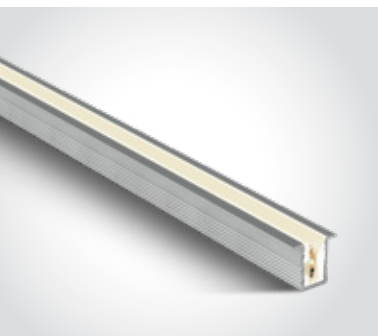
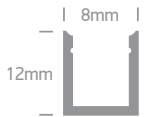

**7901AR/AL** | 2m Recessed profile | Aluminium | Suitable for 7841 LED Strip



Complete with 2 pairs end caps.

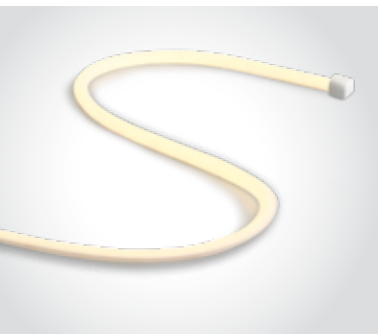
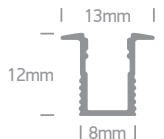

**7811** | 10W/m | SMD 2216 | 192 LEDs | Silicone

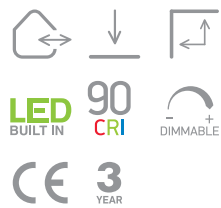

IP67



Supplied in 5m roll.



7811F Fixing clip  
7811E End cap



Order Code	Light Colour	CCT (K)	Watts	Lumen (lm)	Input	Class	Box Icon	Notes
7811/W	Warm white	3000K	10W/m	550lm/m	24V DC	III	40	Requires 24V DC driver / Avoid direct sunlight



# Neon Flex Lightlines

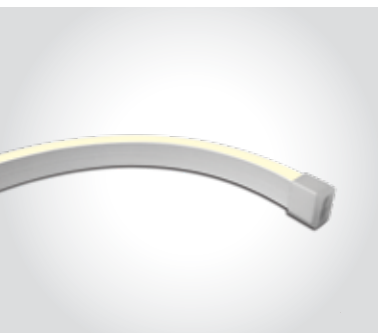

**7841A** | 10W/m | SMD 2835 | 180LEDs/m | Silicone

Supplied in 5m roll.

**new**  
**IP66**

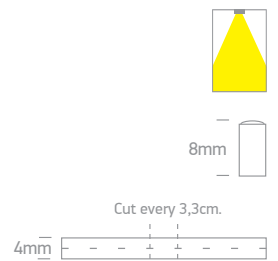
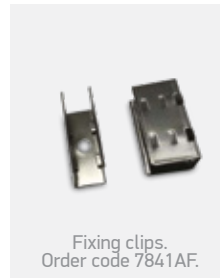
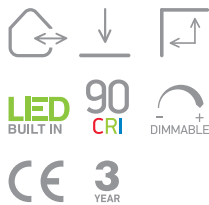

**7841** | 14,4W/m | SMD 2835 | 140LEDs/m | Silicone

**IP66**

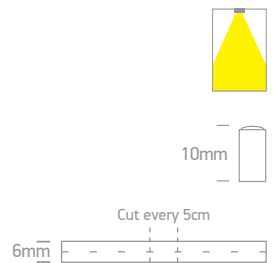
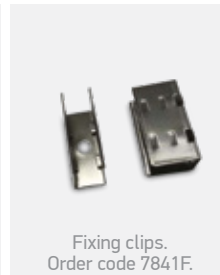

**7841B** | 12W/m | SMD 2835 | 140LEDs/m | Silicone

Supplied in 5m roll.

**new**  
**IP66**

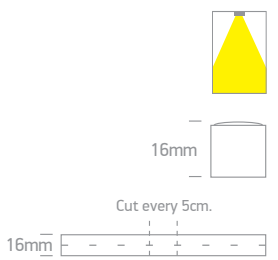
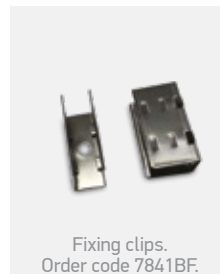

Order Code	Light Colour	CCT (K)	Watts	Lumen (lm)	Input	Class	📦	Notes
<b>7841A/C</b>	Cool white	4000K	10W/m	280lm/m	24V DC	⚡	40	Requires 24V DC driver / Avoid direct sunlight
<b>7841A/W</b>	Warm white	3000K	10W/m	280lm/m	24V DC	⚡	40	Requires 24V DC driver / Avoid direct sunlight
<b>7841/C</b>	Cool white	4000K	14,4W/m	360lm/m	24V DC	⚡	40	Requires 24V DC driver / Avoid direct sunlight
<b>7841/W</b>	Warm white	3000K	14,4W/m	320lm/m	24V DC	⚡	40	Requires 24V DC driver / Avoid direct sunlight
<b>7841B/C</b>	Cool white	4000K	12W/m	600lm/m	24V DC	⚡	10	Requires 24V DC driver / Avoid direct sunlight
<b>7841B/W</b>	Warm white	3000K	12W/m	550lm/m	24V DC	⚡	10	Requires 24V DC driver / Avoid direct sunlight





## Decorative Light Tubes



**7868** | 3,4W/m | LED | 30LEDs/m | Festive lighting | PVC

Connect maximum 100m / Cut every 1m.



**LED**  
BUILT IN

**CE**

**2**  
YEAR



Supplied in 50m roll.



**IP65**

13mm



**7868P**  
230V Power supply for 50m.



**7868F** Fixing clip.



**7868E** End cap.

Order Code	Light Colour	CCT (K)	Watts	Input	Class	Class	Notes
<b>7868/D</b>	Daylight	6000K	3,4W/m	230V		50m roll	Complete with 7868P power supply



## Decorative Light Stars



7866/EW  
Supplied in 10m roll.

IP54

7866 | 7W | LED | 100LEDs | Festive lighting | PVC

Connect maximum 100m.



LED  
BUILT IN

CE

2  
YEAR

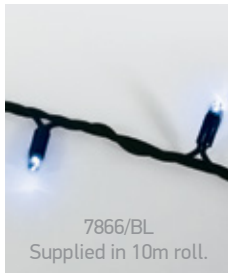

7866/BL  
Supplied in 10m roll.

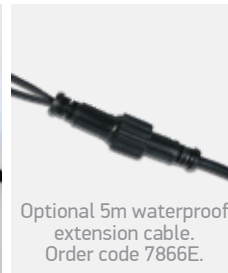

Optional 5m waterproof  
extension cable.  
Order code 7866E.



7866F/D  
Supplied in 10m roll.

IP54

7866F | 7W | LED | 100LEDs | Flashing lights | Festive lighting | PVC

Connect maximum 100m.



LED  
BUILT IN

CE

2  
YEAR

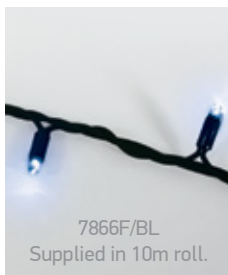



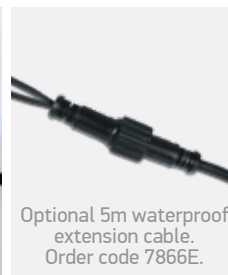

7866F/BL  
Supplied in 10m roll.



Optional 5m waterproof  
extension cable.  
Order code 7866E.



Order Code	Light Colour	CCT (K)	Watts	Input	Class		Notes
7866/EW	Extra warm white	2700K	7W	230V		10	Complete with power supply
7866/BL	Blue	-	7W	230V		10	Complete with power supply
7866F/D	Daylight	6000K	7W	230V		10	Complete with power supply
7866F/BL	Blue	-	7W	230V		10	Complete with power supply