

NEW
PRODUCTS
2025

EDITION 2

Recessed Spots Fixed



10105ALG | 10W | MR16 | GU10 | Aluminium

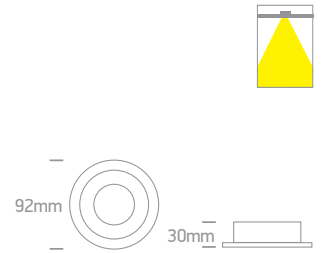

Order Code	Colour	Reflector	Watts	Input	Class					Notes
10105ALG/W/BS	White	Brass	10W	100-240V		15cm	78mm	150mm	50	-



10105AD | 10W | MR16 | GU10 | Aluminium

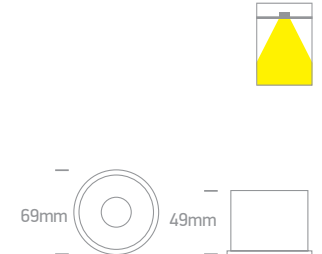

Order Code	Colour	Reflector	Watts	Input	Class					Notes
10105AD/W/W	White	White	10W	100-240V		15cm	64mm	130mm	36	-
10105AD/B/B	Black	Black	10W	100-240V		15cm	64mm	130mm	36	-



10105D8 | 10W | MR16 | GU10 | Aluminium

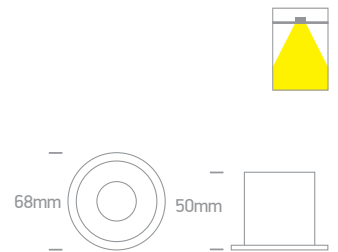

Order Code	Colour	Reflector	Watts	Input	Class					Notes
10105D8/B/BS	Black	Brass	10W	100-240V		15cm	62mm	130mm	50	-



10105Y/W

10105Y | 10W | MR16 | GU10 | Aluminium

new
DARK LIGHT
IP20

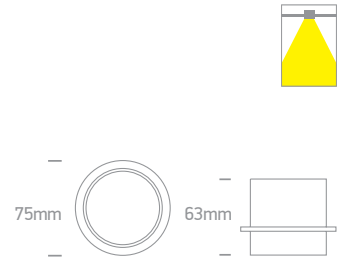

10105Y/B

10105Y | 10W | MR16 | GU10 | Aluminium

new
DARK LIGHT
IP20

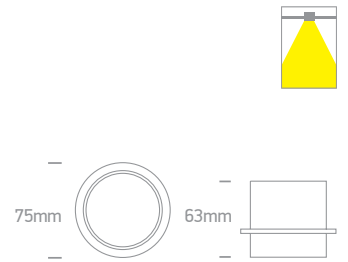

Order Code	Colour	Watts	Input	Class					Notes
10105Y/W	White	10W	100-240V		15cm	68mm	120mm	50	-
10105Y/B	Black	10W	100-240V		15cm	68mm	120mm	50	-



10105YTR/W

10105YTR | 10W | MR16 | GU10 | Trimless | Aluminium

new
DARK LIGHT
IP20

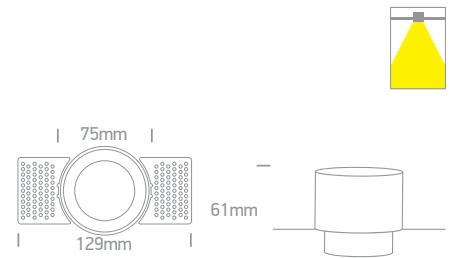

Order Code	Colour	Watts	Input	Class					Notes
10105YTR/W	White	10W	100-240V		15cm	80mm	130mm	50	-

Recessed Spots Fixed LED

10103LB | 3W | COB LED | Aluminium



10103LB/W/W

new
DARK LIGHT
IP20

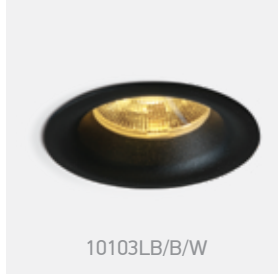

10103LB/B/W



Order Code	Colour	Light Colour	CCT (K)	Watts	Lumen (lm)	Beam Angle	Input	Class					Notes
10103LB/W/W	White	Warm white	3000K	3W	300lm	36°	350mA		40cm	38mm	55mm	100	Requires 350mA driver
10103LB/B/W	Black	Warm white	3000K	3W	300lm	36°	350mA		40cm	38mm	55mm	100	Requires 350mA driver

10107DB | 6,5W | COB LED | Aluminium



10107DB/B/W

new
DARK LIGHT
IP65

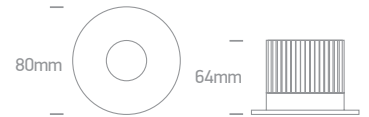
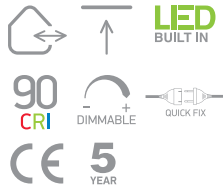

Order Code	Colour	Light Colour	CCT (K)	Watts	Lumen (lm)	Beam Angle	Input	Class					Notes
10107DB/B/W	Black	Warm white	3000K	6,5W	500lm	36°	700mA		40cm	60mm	80mm	50	Requires 700mA driver

10112C | 12W | COB LED | Die cast



10112C/B/W

new
DARK LIGHT
IP65



Order Code	Colour	Light Colour	CCT (K)	Watts	Lumen (lm)	Beam Angle	Input	Class					Notes
10112C/B/W	Black	Warm white	3000K	12W	1100lm	40°	700mA		40cm	75mm	120mm	50	Requires 700mA driver



10107A/W/W

10107A | 7W | SMD LED | Die cast

Semi-Recessed.



new

IP20



10107A/B/W

10107A | 7W | SMD LED | Die cast

Semi-Recessed.



new

IP20



Order Code	Colour	Light Colour	CCT (K)	Watts	Lumen (lm)	Beam Angle	Input	Class				Notes
10107A/W/W	White	Warm white	3000K	7W	600lm	38°	230V		54mm	40mm	50	Complete with 180mA driver
10107A/B/W	Black	Warm white	3000K	7W	600lm	38°	230V		54mm	40mm	50	Complete with 180mA driver

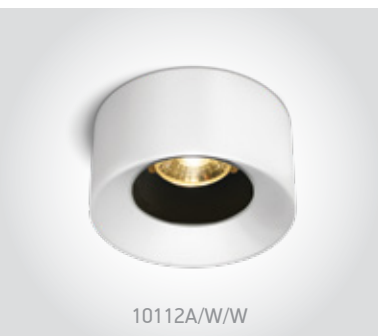

10112A/W/W

10112A | 12W | SMD LED | Die cast

Semi-Recessed.



new

IP20

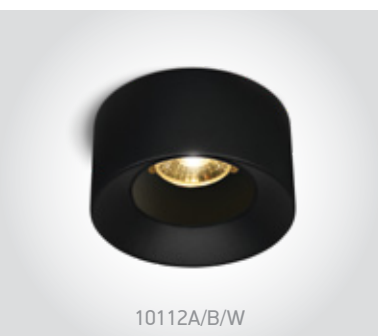
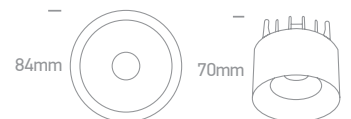

10112A/B/W

10112A | 12W | SMD LED | Die cast

Semi-Recessed.



new

IP20

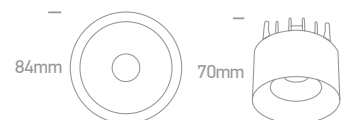

Order Code	Colour	Light Colour	CCT (K)	Watts	Lumen (lm)	Beam Angle	Input	Class				Notes
10112A/W/W	White	Warm white	3000K	12W	1100lm	38°	230V		72mm	40mm	50	Complete with 300mA driver
10112A/B/W	Black	Warm white	3000K	12W	1100lm	38°	230V		72mm	40mm	50	Complete with 300mA driver

Downlights Fixed LED



10110U | 10W | SMD LED | Die cast

new
IP44

LED BUILT IN
80 CRI

CE
UGR19

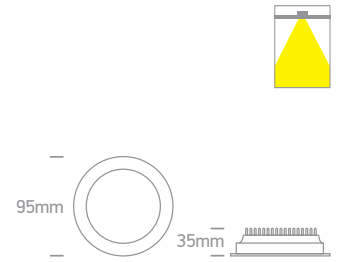

Order Code	Colour	Light Colour	CCT (K)	Watts	Lumen (lm)	Input	Class				Notes
10110U/W/V	White	CCT V	3000K-4000K-6000K	10W	850lm	230V		86mm	55mm	40	Complete with 200mA driver



10124U | 24W | SMD LED | Die cast

new
IP44

LED BUILT IN
80 CRI

CE
UGR19

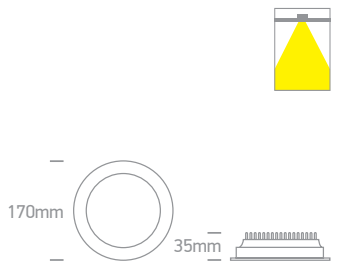

Order Code	Colour	Light Colour	CCT (K)	Watts	Lumen (lm)	Input	Class				Notes
10124U/W/V	White	CCT V	3000K-4000K-6000K	24W	2000lm	230V		160mm	55mm	20	Complete with 500mA driver



10130U | 30W | SMD LED | Die cast

new
IP44

LED BUILT IN
80 CRI

CE
UGR19

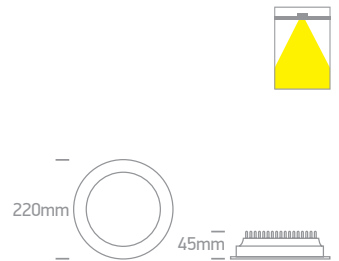

Order Code	Colour	Light Colour	CCT (K)	Watts	Lumen (lm)	Input	Class				Notes
10130U/W/V	White	CCT V	3000K-4000K-6000K	30W	2500lm	230V		205mm	65mm	10	Complete with 750mA driver

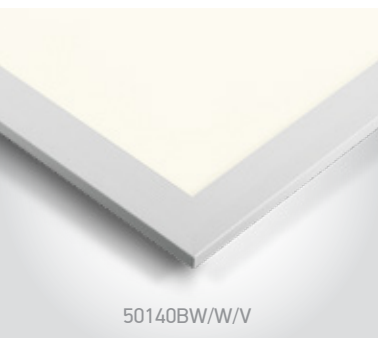

50140BW | 40W | SMD LED | 595x595mm | Aluminium + Steel

Backlit.

new
IP65

LED BUILT IN
80 CRI
CE
3 YEAR

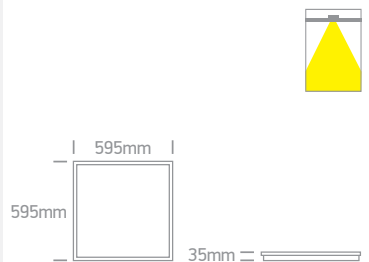
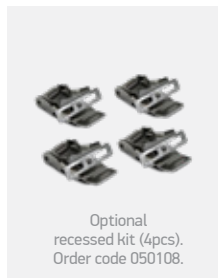
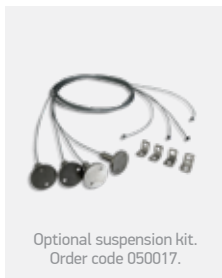

Order Code	Colour	Light Colour	CCT (K)	Watts	Lumen (lm)	Input	Class				Notes
50140BW/W/V	White	CCT V	3000K-4000K-5700K	40W	4000lm	230V		60mm	4	Complete with IP65 950mA driver	



10107B | 7W | SMD LED | Die cast

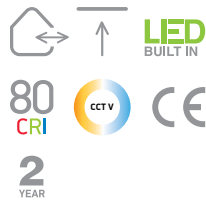

new
IP54

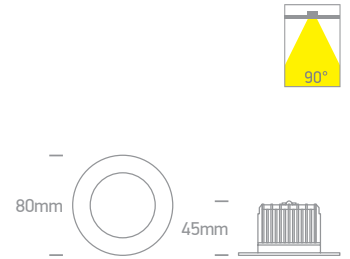

Order Code	Colour	Light Colour	CCT (K)	Watts	Lumen (lm)	Beam Angle	Input	Class				Notes
10107B/W/V	White	CCT V	3000K-4000K-5000K	7W	540lm	90°	230V		65mm	70mm	50	Complete with 180mA driver



10113B | 13W | SMD LED | Die cast

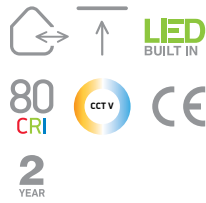

new
IP54

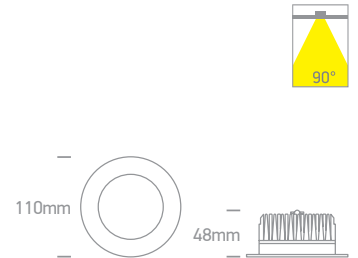

Order Code	Colour	Light Colour	CCT (K)	Watts	Lumen (lm)	Beam Angle	Input	Class				Notes
10113B/W/V	White	CCT V	3000K-4000K-5000K	13W	950lm	90°	230V		95mm	70mm	24	Complete with 300mA driver



10118B | 18W | SMD LED | Die cast



new
IP54

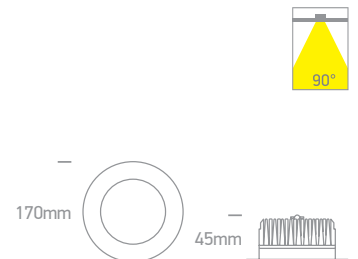

Order Code	Colour	Light Colour	CCT (K)	Watts	Lumen (lm)	Beam Angle	Input	Class				Notes
10118B/W/V	White	CCT V	3000K-4000K-5000K	18W	1400lm	90°	230V		140mm	70mm	30	Complete with 450mA driver



10125B | 25W | SMD LED | Die cast



new
IP54

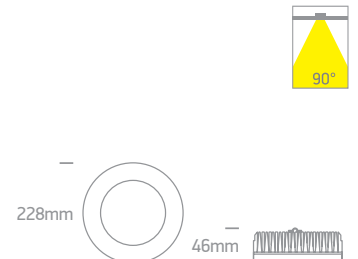

Order Code	Colour	Light Colour	CCT (K)	Watts	Lumen (lm)	Beam Angle	Input	Class				Notes
10125B/W/V	White	CCT V	3000K-4000K-5000K	25W	2000lm	90°	230V		210mm	80mm	10	Complete with 650mA driver

Downlights Fixed LED

10109D | 12W | SMD LED | Die cast



10109D/W/V

new
DARK LIGHT
IP20

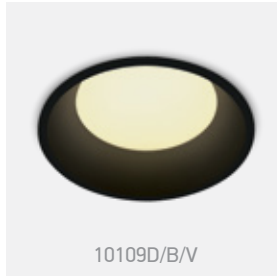
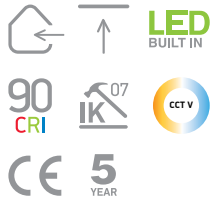

10109D/B/V

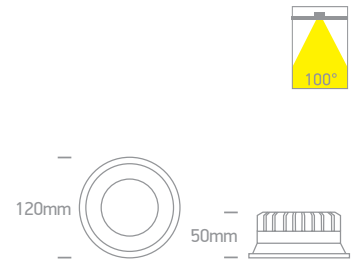

Order Code	Colour	Light Colour	CCT (K)	Watts	Lumen (lm)	Beam Angle	Input	Class	Lighting	Height	Depth	Notes
10109D/W/V	White	CCT V	3000K-4000K-5000K	12W	1000lm	100°	230V	□	110mm	70mm	40	Complete with 300mA driver
10109D/B/V	Black	CCT V	3000K-4000K-5000K	12W	1000lm	100°	230V	□	110mm	70mm	40	Complete with 300mA driver

10122D | 22W | SMD LED | Die cast



10122D/W/V

new
DARK LIGHT
IP20

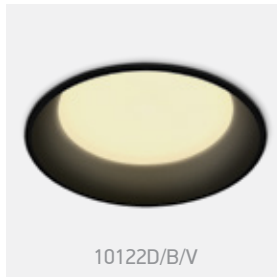
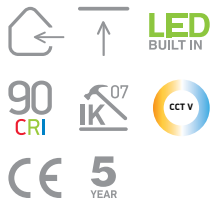

10122D/B/V

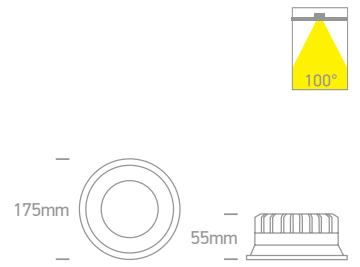

Order Code	Colour	Light Colour	CCT (K)	Watts	Lumen (lm)	Beam Angle	Input	Class	Lighting	Height	Depth	Notes
10122D/W/V	White	CCT V	3000K-4000K-5000K	22W	1900lm	100°	230V	□	165mm	70mm	20	Complete with 600mA driver
10122D/B/V	Black	CCT V	3000K-4000K-5000K	22W	1900lm	100°	230V	□	165mm	70mm	20	Complete with 600mA driver

10109FD | 9W | SMD LED | Die cast



10109FD/W/V

new
DARK LIGHT
IP65



10109FD/B/V

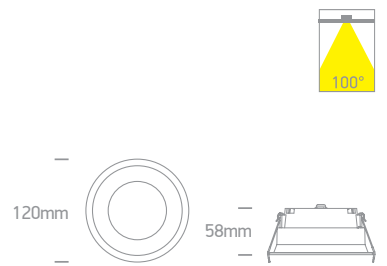

Order Code	Colour	Light Colour	CCT (K)	Watts	Lumen (lm)	Beam Angle	Input	Class	Lighting	Height	Depth	Notes
10109FD/W/V	White	CCT V	3000K-4000K-5000K	9W	900lm	100°	230V	□	111mm	80mm	40	Complete with 220mA driver
10109FD/B/V	Black	CCT V	3000K-4000K-5000K	9W	900lm	100°	230V	□	111mm	80mm	40	Complete with 220mA driver

10120FD | 20W | SMD LED | Die cast



10120FD/W/V

new
DARK LIGHT
IP65



10120FD/B/V

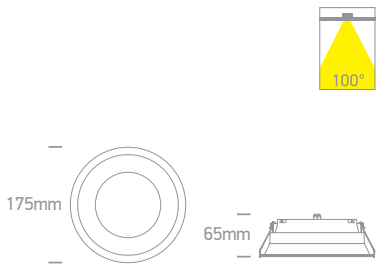

Order Code	Colour	Light Colour	CCT (K)	Watts	Lumen (lm)	Beam Angle	Input	Class	Lighting	Height	Depth	Notes
10120FD/W/V	White	CCT V	3000K-4000K-5000K	20W	2000lm	100°	230V	□	166mm	85mm	20	Complete with 500mA driver
10120FD/B/V	Black	CCT V	3000K-4000K-5000K	20W	2000lm	100°	230V	□	166mm	85mm	20	Complete with 500mA driver

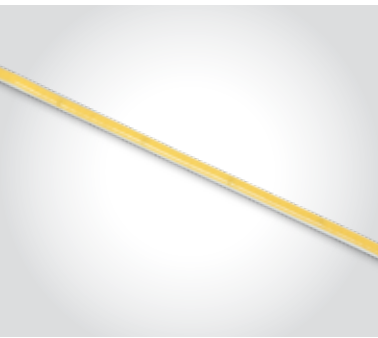

7843E | 10W/m | COB LED | 400LEDs/m | Ultra slim

3M Double face adhesive.

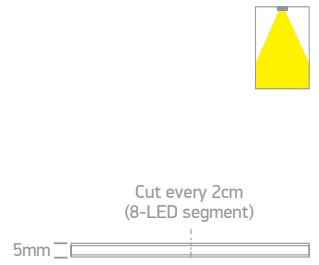
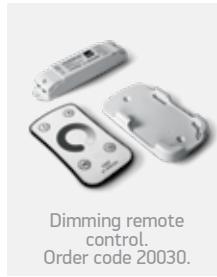
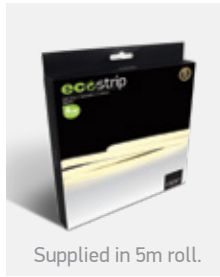
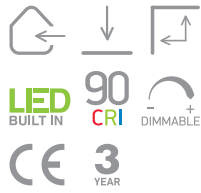

new
IP20

Order Code	Light Colour	CCT (K)	Watts	Lumen (lm)	Input	Class	Box	Notes
7843E/C	Cool white	4000K	10W/m	900lm/m	24V DC	III	50	Requires 24V DC driver
7843E/W	Warm white	3000K	10W/m	810lm/m	24V DC	III	50	Requires 24V DC driver
7843E/EW	Extra warm white	2700K	10W/m	790lm/m	24V DC	III	50	Requires 24V DC driver



7844E | 10,5W/m | COB LED | 480LEDs/m

3M Double face adhesive.

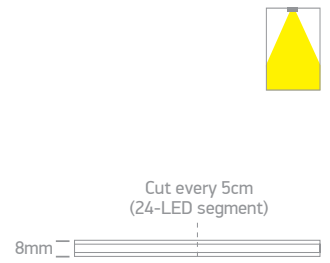
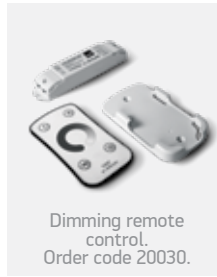
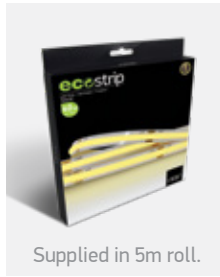
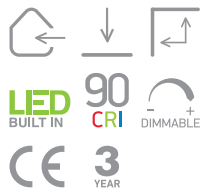

new
IP20

Order Code	Light Colour	CCT (K)	Watts	Lumen (lm)	Input	Class	Box	Notes
7844E/C	Cool white	4000K	10,5W/m	950lm/m	24V DC	III	40	Requires 24V DC driver
7844E/W	Warm white	3000K	10,5W/m	860lm/m	24V DC	III	40	Requires 24V DC driver
7844E/EW	Extra warm white	2700K	10,5W/m	820lm/m	24V DC	III	40	Requires 24V DC driver



7844 | 10W/m | COB LED | 480LEDs/m

Supplied in 5m roll / 3M Double face adhesive.

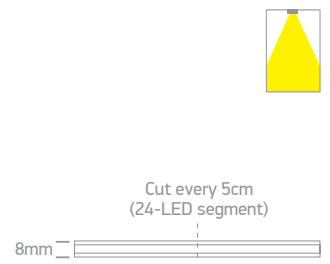
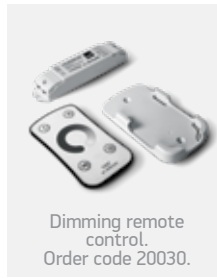

new
IP20

Order Code	Light Colour	CCT (K)	Watts	Input	Class	Box	Notes
7844/A	Amber	2000K	10W/m	24V DC	III	50	Requires 24V DC driver



7846 | RGBW | 18W/m | COB LED | 840LEDs/m

Supplied in 5m roll / 3M Double face adhesive.

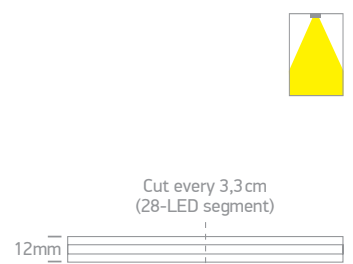
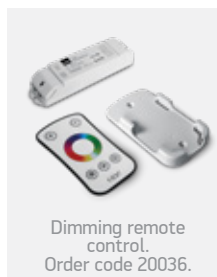

new
IP20

Order Code	Light Colour	CCT (K)	Watts	Lumen (lm)	Input	Class	Box	Notes
7846/RGBW	RGB + Warm white	RGB + 3000K	RGB 12W/m + WW 6W/m	500lm/m (3000K)	24V DC	III	50	Requires 24V DC driver

Strips & Profiles



7940/B

new

7940 | Wall-to-wall-kit | Aluminium | Suitable for LED strips up to 15mm

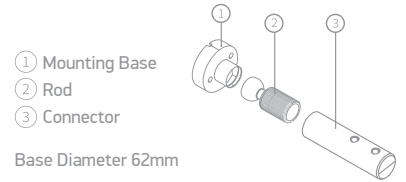

Order Code	Colour		Notes
7940/B	Black	25	Requires 7940A/B or 7940B/B



7940A/B

new

7940A | 10m Metal belt for 7940 | Suitable for LED strips up to 15mm



Order Code	Colour		Notes
7940A/B	Black	25	-



7940B/B

new

7940B | 20m Metal belt for 7940 | Suitable for LED strips up to 15mm



Order Code	Colour		Notes
7940B/B	Black	25	-

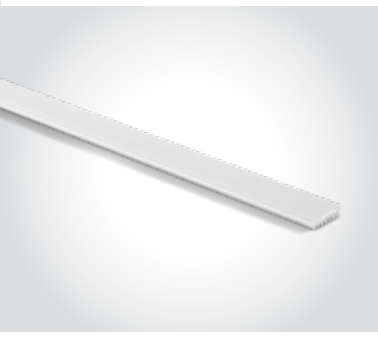

new

7900/W | 2m Profile for heat dissipation | Aluminium | Suitable for LED Strips up to 12mm



Order Code	Colour		Notes
7900/W	White	50	-



38104B | 4W | SMD LED | Plastic

Connect 25 fittings maximum.

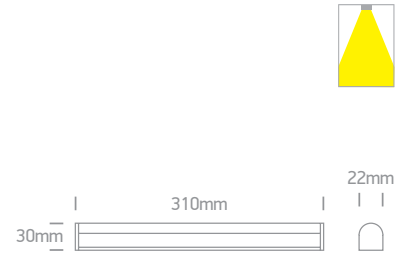

Order Code	Light Colour	CCT (K)	Watts	Lumen (lm)	Input	Class			Notes
38104B/V	CCT V	3000K-4000K-6000K	4W	440lm	230V		120cm	30	Complete with driver



38108B | 8W | SMD LED | Plastic

Connect 12 fittings maximum.

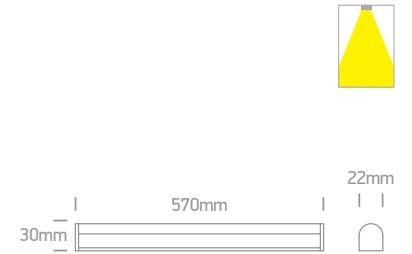

Order Code	Light Colour	CCT (K)	Watts	Lumen (lm)	Input	Class			Notes
38108B/V	CCT V	3000K-4000K-6000K	8W	880lm	230V		120cm	30	Complete with driver



38114B | 14W | SMD LED | Plastic

Connect 7 fittings maximum.

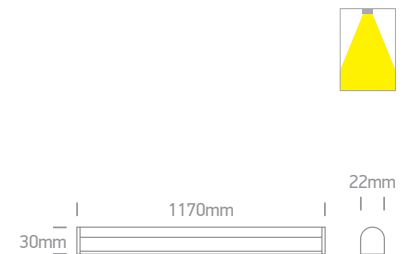
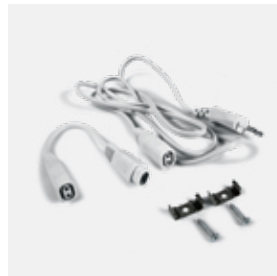

Order Code	Light Colour	CCT (K)	Watts	Lumen (lm)	Input	Class			Notes
38114B/V	CCT V	3000K-4000K-6000K	14W	1540lm	230V		120cm	30	Complete with driver

Track Lights



65105NT | 10W | MR16 | GU10 | Aluminium



new
DARK LIGHT
IP20

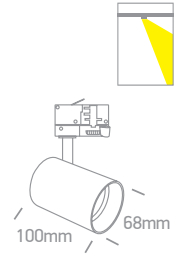

Order Code	Colour	Reflector	Watts	Input	Class	Box	Notes
65105NT/W/W	White	White	10W	100-240V	⊕	12	-
65105NT/B/B	Black	Black	10W	100-240V	⊕	12	-



65105DT | 10W | MR16 | GU10 | Aluminium



new
DARK LIGHT
IP20

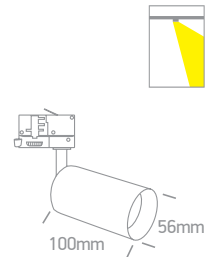

65105DT | 10W | MR16 | GU10 | Aluminium



new
DARK LIGHT
IP20

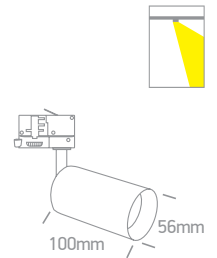
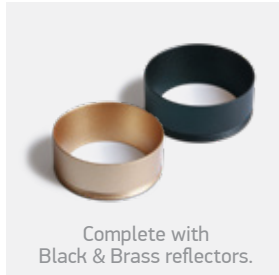

Order Code	Colour	Reflector	Watts	Input	Class	Box	Notes
65105DT/W	White	Black & White	10W	100-240V	⊕	40	-
65105DT/B	Black	Black & Brass	10W	100-240V	⊕	40	-



63108AT | 8W | COB LED | Die cast



new
IP20

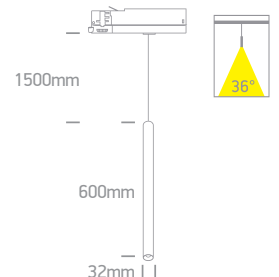

Order Code	Colour	Reflector	Light Colour	CCT (K)	Watts	Lumen (lm)	Beam Angle	Input	Class	Box	Notes
63108AT/W/W	White	White	Warm white	3000K	8W	560lm	36°	230V	⊕	20	Complete with 300mA driver
63108AT/B/W	Black	Black	Warm white	3000K	8W	560lm	36°	230V	⊕	20	Complete with 300mA driver



65026T/W/V

new
IP20

65026T | 40W | SMD LED | Linear track light | Aluminium + plastic

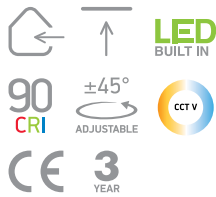

65026T/B/V

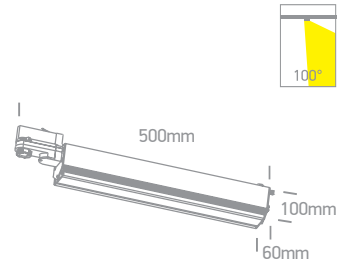

Order Code	Colour	Light Colour	CCT (K)	Watts	Lumen (lm)	Beam Angle	Input	Class	Box	Notes
65026T/W/V	White	CCT V	3000K-4000K-5000K	40W	3400lm	100°	230V	⊕	10	Complete with 1000mA driver
65026T/B/V	Black	CCT V	3000K-4000K-5000K	40W	3400lm	100°	230V	⊕	10	Complete with 1000mA driver



65018T/W/V

new
IP20

65018T | 16W | SMD LED | Linear track light | Aluminium + PC



65018T/B/V

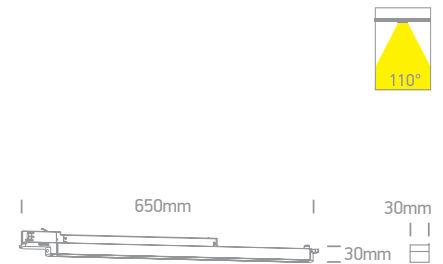

Order Code	Colour	Light Colour	CCT (K)	Watts	Lumen (lm)	Beam Angle	Input	Class	Box	Notes
65018T/W/V	White	CCT V	3000K-4000K-5000K	16W	1600lm	110°	100-240V	⊕	12	Complete with 400mA driver
65018T/B/V	Black	CCT V	3000K-4000K-5000K	16W	1600lm	110°	100-240V	⊕	12	Complete with 400mA driver



65025T/W/V

new
IP20

65025T | 25W | SMD LED | Linear track light | Aluminium + PC



65025T/B/V

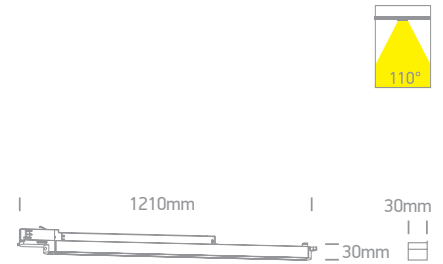

Order Code	Colour	Light Colour	CCT (K)	Watts	Lumen (lm)	Beam Angle	Input	Class	Box	Notes
65025T/W/V	White	CCT V	3000K-4000K-5000K	25W	2500lm	110°	100-240V	⊕	12	Complete with 600mA driver
65025T/B/V	Black	CCT V	3000K-4000K-5000K	25W	2500lm	110°	100-240V	⊕	12	Complete with 600mA driver



65170BT/W/V

new
IP20

65170BT | 60W PV | SMD LED | Linear track light | Aluminium

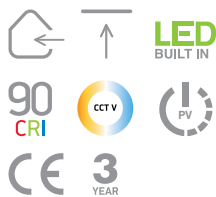

65170BT/B/V

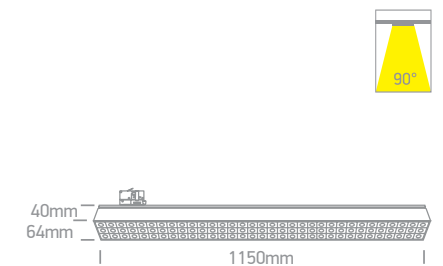

Order Code	Colour	Light Colour	CCT (K)	Watts	Lumen (lm)	Beam Angle	Input	Class	Box	Notes
65170BT/W/V	White	CCT V	3000K-4000K-5000K	40W-50W-60W	5400lm	90°	230V	⊕	12	Complete with PV driver
65170BT/B/V	Black	CCT V	3000K-4000K-5000K	40W-50W-60W	5400lm	90°	230V	⊕	12	Complete with PV driver

Tracks & Magnetic



42003 | 48V | 3m Magnetic profile | ON/OFF / DALI | Aluminium

Max 10m/driver | Max 400W/circuit.



new

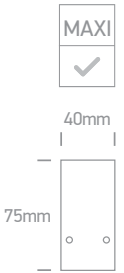
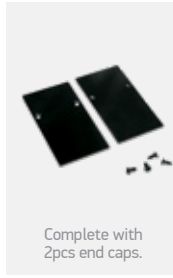

Order Code	Colour	Length	Input	Class		Notes
42003/B	Black	3m	48V		1	-



bALI

42100AL | 15W | SMD LED | Linear light | DALI | Aluminium + PC



new

IP20

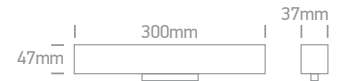
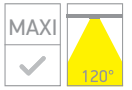

Order Code	Colour	Light Colour	CCT (K)	Watts	Lumen (lm)	Beam Angle	Input	Class		Notes
42100AL/B/W	Black	Warm white	3000K	15W	1200lm	120°	48V		40	-



12105AL/W/W

12105AL | 10W | MR16 | GU10 | Aluminium

new
DARK LIGHT
IP20

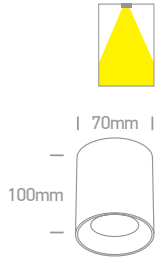

12105AL/W/BS

12105AL | 10W | MR16 | GU10 | Aluminium

new
DARK LIGHT
IP20

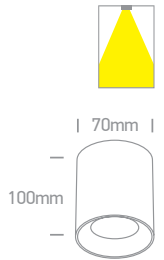

Order Code	Colour	Reflector	Watts	Input	Class		Notes
12105AL/W/W	White	White	10W	100-240V		20	-
12105AL/W/BS	White	Brass	10W	100-240V		20	-



12105N/W/W

12105N | 10W | MR16 | GU10 | Aluminium

new
DARK LIGHT
IP20

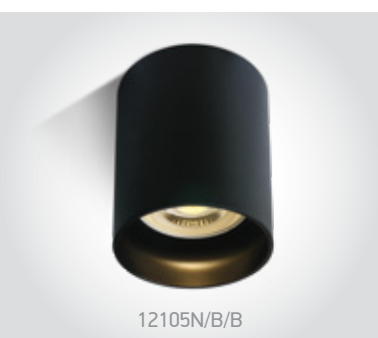
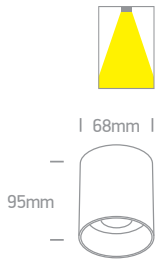

12105N/B/B

12105N | 10W | MR16 | GU10 | Aluminium

new
DARK LIGHT
IP20

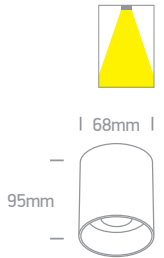

Order Code	Colour	Reflector	Watts	Input	Class		Notes
12105N/W/W	White	White	10W	100-240V		20	-
12105N/B/B	Black	Black	10W	100-240V		20	-

Office & Kitchen



38150A/W/V

38150A | 40W PV | SMD LED | Linear system | Diffuser | Aluminium

Can be connected in line.

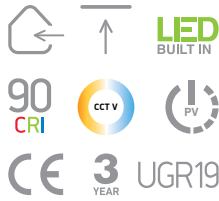

new
IP20



38150A/B/V



Complete with 4 fixing clips & 4 connectors.



Order Code	Colour	Light Colour	CCT (K)	Watts	Lumen (lm)	Input	Class			Notes
38150A/W/V	White	CCT V	3000K-4000K-5000K	20W-30W-40W	3400lm (40W)	230V		300cm	12	Complete with PV driver
38150A/B/V	Black	CCT V	3000K-4000K-5000K	20W-30W-40W	3400lm (40W)	230V		300cm	12	Complete with PV driver



38151A/W/V

38151A | 50W PV | SMD LED | Linear system | Diffuser | Aluminium

Can be connected in line.



new
IP20



38151A/B/V



Complete with 4 fixing clips & 4 connectors.



Order Code	Colour	Light Colour	CCT (K)	Watts	Lumen (lm)	Input	Class			Notes
38151A/W/V	White	CCT V	3000K-4000K-5000K	30W-40W-50W	4250lm (50W)	230V		300cm	12	Complete with PV driver
38151A/B/V	Black	CCT V	3000K-4000K-5000K	30W-40W-50W	4250lm (50W)	230V		300cm	12	Complete with PV driver

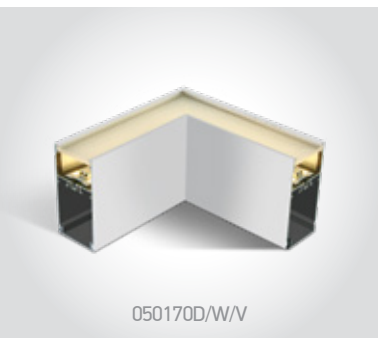

050170D/W/V

050170D | 14W PV | SMD LED | Corner for 38150A & 38151A | Diffuser | Aluminium

Can be connected in line.

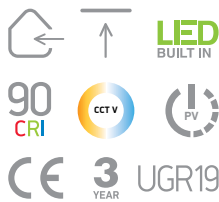

new
IP20



050170D/B/V



Complete with 4 fixing clips & 4 connectors.

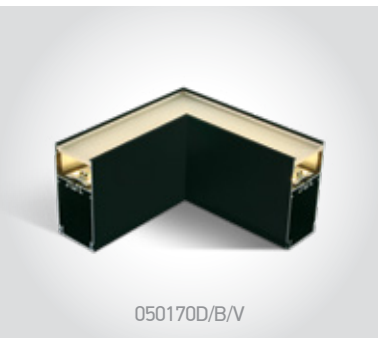
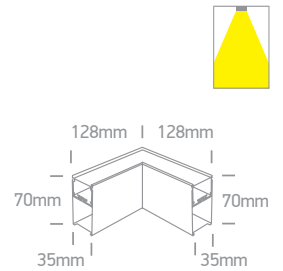

050170D/B/V

050170D | 14W PV | SMD LED | Corner for 38150A & 38151A | Diffuser | Aluminium

Can be connected in line.

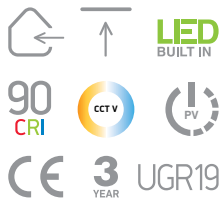

new
IP20



050170D/B/V



Complete with 4 fixing clips & 4 connectors.

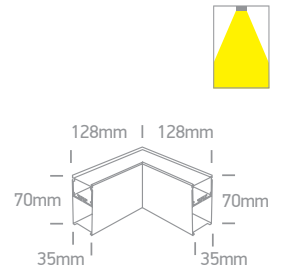

Order Code	Colour	Light Colour	CCT (K)	Watts	Lumen (lm)	Input	Class			Notes
050170D/W/V	White	CCT V	3000K-4000K-5000K	6W-8W-10W-14W	680lm (8W)	230V		150cm	10	Complete with PV driver
050170D/B/V	Black	CCT V	3000K-4000K-5000K	6W-8W-10W-14W	680lm (8W)	230V		150cm	10	Complete with PV driver



38160A/W/V

38160A | 40W PV | SMD LED | Linear system | Diffuser | Aluminium

Can be connected in line.

new
IP20

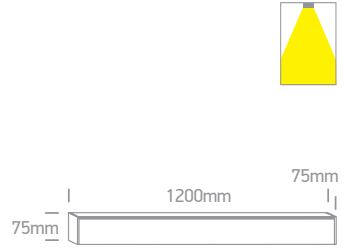
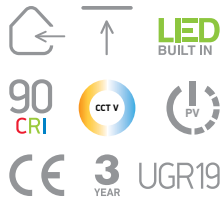

38160A/B/V

38160A | 40W PV | SMD LED | Linear system | Diffuser | Aluminium

Can be connected in line.

new
IP20

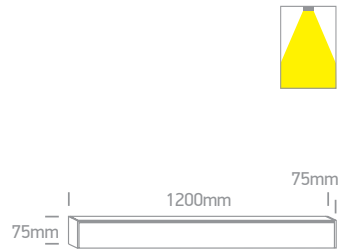
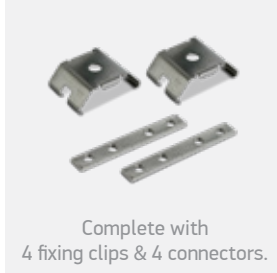
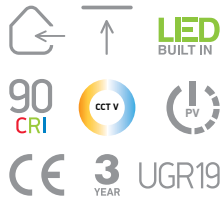

Order Code	Colour	Light Colour	CCT (K)	Watts	Lumen (lm)	Input	Class			Notes
38160A/W/V	White	CCT V	3000K-4000K-5000K	20W-30W-40W	3400lm (40W)	230V		300cm	12	Complete with PV driver
38160A/B/V	Black	CCT V	3000K-4000K-5000K	20W-30W-40W	3400lm (40W)	230V		300cm	12	Complete with PV driver



38161A/W/V

38161A | 50W PV | SMD LED | Linear System | Diffuser | Aluminium

Can be connected in line.

new
IP20

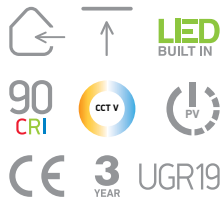

38161A/B/V

38161A | 50W PV | SMD LED | Linear System | Diffuser | Aluminium

Can be connected in line.

new
IP20

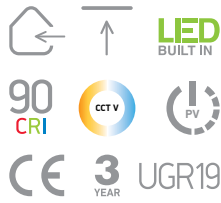

Order Code	Colour	Light Colour	CCT (K)	Watts	Lumen (lm)	Input	Class			Notes
38161A/W/V	White	CCT V	3000K-4000K-5000K	30W-40W-50W	4250lm (50W)	230V		300cm	9	Complete with PV driver
38161A/B/V	Black	CCT V	3000K-4000K-5000K	30W-40W-50W	4250lm (50W)	230V		300cm	9	Complete with PV driver

Office & Kitchen

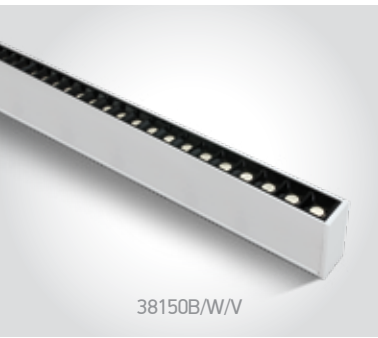

38150B/W/V

38150B | 40W PV | 48LEDs | Linear system | Aluminium

Can be connected in line.

new
DARK LIGHT
IP20

90 CRI
CCT V
CE
3 YEAR
LED BUILT IN
UGR17
PV



38150B/B/V

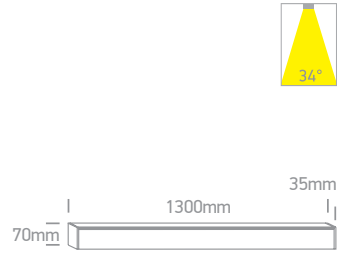
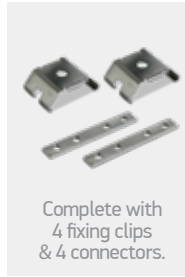

Order Code	Colour	Light Colour	CCT (K)	Watts	Lumen (lm)	Beam Angle	Input	Class	Ⓢ	📦	Notes
38150B/W/V	White	CCT V	3000K-4000K-5000K	20W-30W-40W	3800lm (40W)	34°	230V	Ⓢ	300cm	12	Complete with PV driver
38150B/B/V	Black	CCT V	3000K-4000K-5000K	20W-30W-40W	3800lm (40W)	34°	230V	Ⓢ	300cm	12	Complete with PV driver



38150C/W/V

38150C | 40W PV | 24LEDs + Diffuser | Linear system | Aluminium

Can be connected in line.

new
IP20

90 CRI
CCT V
CE
3 YEAR
LED BUILT IN
UGR19
PV



38150C/B/V

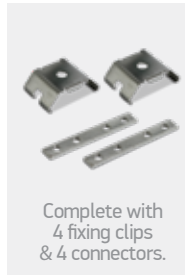

Order Code	Colour	Light Colour	CCT (K)	Watts	Lumen (lm)	Input	Class	Ⓢ	📦	Notes
38150C/W/V	White	CCT V	3000K-4000K-5000K	20W-30W-40W	3400lm (40W)	230V	Ⓢ	300cm	12	Complete with PV driver
38150C/B/V	Black	CCT V	3000K-4000K-5000K	20W-30W-40W	3400lm (40W)	230V	Ⓢ	300cm	12	Complete with PV driver

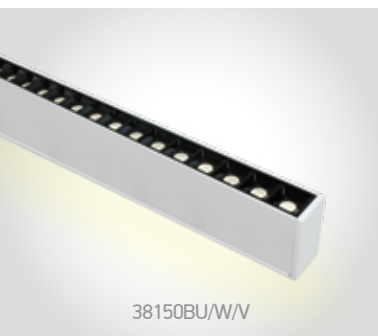

38150BU/W/V

38150BU | 40W PV + 25W PV Uplight | 48LEDs + Diffuser | Linear system | Aluminium

Can be connected in line.

new
DARK LIGHT
IP20

90 CRI
CCT V
CE
3 YEAR
LED BUILT IN
UGR17
PV



38150BU/B/V

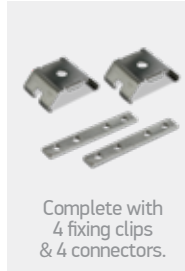

Order Code	Colour	Light Colour	CCT (K)	Watts	Lumen (lm)	Beam Angle	Input	Class	Ⓢ	📦	Notes
38150BU/W/V	White	CCT V	3000K-4000K-5000K	20W-30W-40W+16W-20W-25W	3800lm/1800lm	34°/120°	230V	Ⓢ	300cm	12	Complete with 2x PV drivers
38150BU/B/V	Black	CCT V	3000K-4000K-5000K	20W-30W-40W+16W-20W-25W	3800lm/1800lm	34°/120°	230V	Ⓢ	300cm	12	Complete with 2x PV drivers



38145BR/W/V

38145BR | 40W PV | SMD LED | Recessed linear system | Aluminium

Can be connected in line.

new
DARK LIGHT
IP20

90 CRI
CCT V
CE
3 YEAR
LED BUILT IN
UGR17
PV

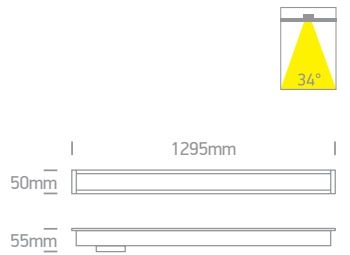

Order Code	Colour	Light Colour	CCT (K)	Watts	Lumen (lm)	Beam Angle	Input	Class	Ⓢ	Ⓢ	📦	Notes
38145BR/W/V	White	CCT V	3000K-4000K-5000K	20W-30W-40W	4000lm (40W)	34°	230V	Ⓢ	1280x37mm	80mm	12	Complete with PV driver



38145AR | 40W PV | SMD LED | Recessed linear system | Aluminium

Can be connected in line.

new
IP20

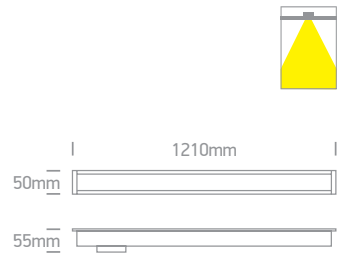
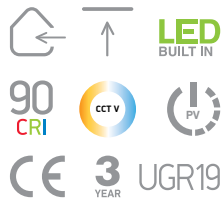

38145AR/W/V

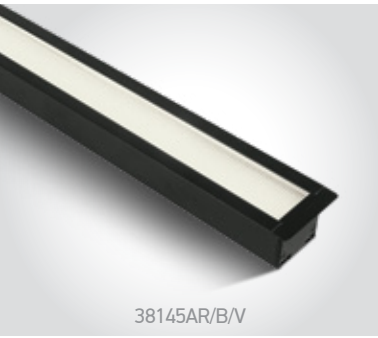

38145AR | 40W PV | SMD LED | Recessed linear system | Aluminium

Can be connected in line.

new
IP20

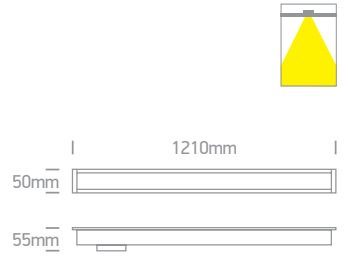
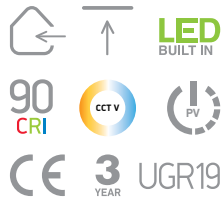

38145AR/B/V

Order Code	Colour	Light Colour	CCT (K)	Watts	Lumen (lm)	Input	Class	Lighting Icon	Dimensions	Box Icon	Notes
38145AR/W/V	White	CCT V	3000K-4000K-5000K	20W-30W-40W	3800lm (40W)	230V	⊕	Lighting Icon	1200x37mm 80mm	12	Complete with PV driver
38145AR/B/V	Black	CCT V	3000K-4000K-5000K	20W-30W-40W	3800lm (40W)	230V	⊕	Lighting Icon	1200x37mm 80mm	12	Complete with PV driver



38152R | 40W PV | SMD LED | Recessed linear system | Aluminium

Can be connected in line.

new
IP20

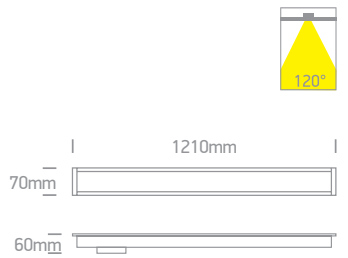
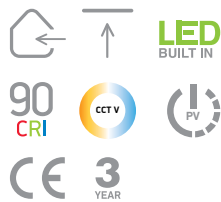

38152R/W/V

Order Code	Colour	Light Colour	CCT (K)	Watts	Lumen (lm)	Beam Angle	Input	Class	Lighting Icon	Dimensions	Box Icon	Notes
38152R/W/V	White	CCT V	3000K-4000K-5000K	20W-30W-40W	3600lm (40W)	120°	230V	⊕	Lighting Icon	1200x60mm 80mm	12	Complete with PV driver



38152RC | 14W PV | SMD LED | Corner for 38152R | Aluminium

new
IP20

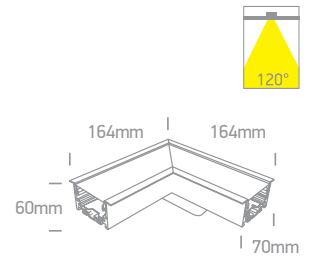
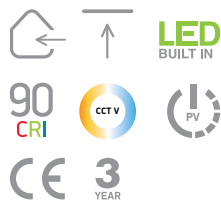

38152RC/W/V

Order Code	Colour	Light Colour	CCT (K)	Watts	Lumen (lm)	Beam Angle	Input	Class	Lighting Icon	Dimensions	Box Icon	Notes
38152RC/W/V	White	CCT V	3000K-4000K-5000K	6W-8W-10W-14W	720lm (8W)	120°	230V	⊕	Lighting Icon	160x160x60mm 80mm	10	Complete with PV driver

Wall & Ceiling LED

12112D | 12W | SMD LED | Aluminium



12112D/W/V

new
IP44



12112D/B/V

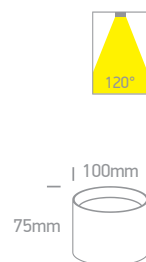

Order Code	Colour	Light Colour	CCT (K)	Watts	Lumen (lm)	Beam Angle	Input	Class	Box	Notes
12112D/W/V	White	CCT V	3000K-4000K-5000K	12W	1200lm	120°	230V	⊕	30	Complete with 300mA driver
12112D/B/V	Black	CCT V	3000K-4000K-5000K	12W	1200lm	120°	230V	⊕	30	Complete with 300mA driver

12120D | 20W | SMD LED | Aluminium

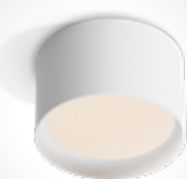

12120D/W/V

new
IP44



12120D/B/V



Order Code	Colour	Light Colour	CCT (K)	Watts	Lumen (lm)	Beam Angle	Input	Class	Box	Notes
12120D/W/V	White	CCT V	3000K-4000K-5000K	20W	2000lm	120°	230V	⊕	30	Complete with 500mA driver
12120D/B/V	Black	CCT V	3000K-4000K-5000K	20W	2000lm	120°	230V	⊕	30	Complete with 500mA driver

12125D | 25W | SMD LED | Aluminium

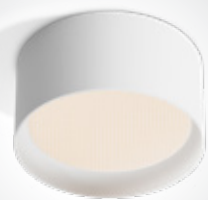

12125D/W/V

new
IP44



12125D/B/V

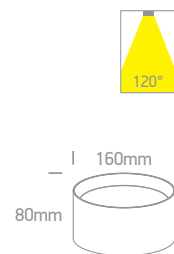

Order Code	Colour	Light Colour	CCT (K)	Watts	Lumen (lm)	Beam Angle	Input	Class	Box	Notes
12125D/W/V	White	CCT V	3000K-4000K-5000K	25W	2500lm	120°	230V	⊕	20	Complete with 650mA driver
12125D/B/V	Black	CCT V	3000K-4000K-5000K	25W	2500lm	120°	230V	⊕	20	Complete with 650mA driver

12130D | 30W | SMD LED | Aluminium



12130D/W/V

new
IP44



12130D/B/V

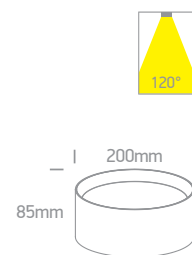

Order Code	Colour	Light Colour	CCT (K)	Watts	Lumen (lm)	Beam Angle	Input	Class	Box	Notes
12130D/W/V	White	CCT V	3000K-4000K-5000K	30W	3000lm	120°	230V	⊕	12	Complete with 750mA driver
12130D/B/V	Black	CCT V	3000K-4000K-5000K	30W	3000lm	120°	230V	⊕	12	Complete with 750mA driver

12107R | 7W | COB LED | Dimmable | Aluminium



12107R/W/W

new
IP20



12107R/B/W



Optional White reflector
code 050106A/W.

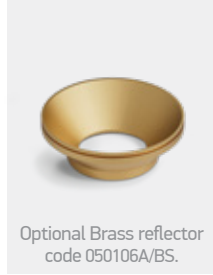

Optional Brass reflector
code 050106A/BS.



Order Code	Colour	Reflector	Light Colour	CCT (K)	Watts	Lumen (lm)	Beam Angle	Input	Class	Box	Notes
12107R/W/W	White	Black	Warm white	3000K	7W	500lm	38°	230V	⊕	50	AC LED
12107R/B/W	Black	Black	Warm white	3000K	7W	500lm	38°	230V	⊕	50	AC LED

12110R | 10W | COB LED | Aluminium



12110R/W/W

new
IP20



12110R/B/W



Optional White reflector
code 050106B/W.



Optional Brass reflector
code 050106B/BS.



Order Code	Colour	Reflector	Light Colour	CCT (K)	Watts	Lumen (lm)	Beam Angle	Input	Class	Box	Notes
12110R/W/W	White	Black	Warm white	3000K	10W	1000lm	38°	230V	⊕	30	Complete with 250mA driver
12110R/B/W	Black	Black	Warm white	3000K	10W	1000lm	38°	230V	⊕	30	Complete with 250mA driver

12118R | 18W | COB LED | Aluminium



12118R/W/W

new
IP20



12118R/B/W



Optional White reflector
code 050106C/W.



Optional Brass reflector
code 050106C/BS.

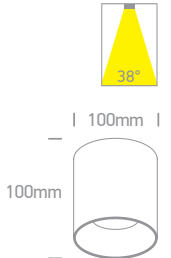

Order Code	Colour	Reflector	Light Colour	CCT (K)	Watts	Lumen (lm)	Beam Angle	Input	Class	Box	Notes
12118R/W/W	White	Black	Warm white	3000K	18W	1800lm	38°	230V	⊕	20	Complete with 450mA driver
12118R/B/W	Black	Black	Warm white	3000K	18W	1800lm	38°	230V	⊕	20	Complete with 450mA driver

12125R | 25W | COB LED | Aluminium



12125R/W/W

new
IP20



12125R/B/W



Optional White reflector
code 050106D/W.



Optional Brass reflector
code 050106D/BS.

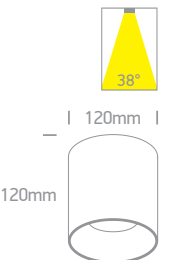

Order Code	Colour	Reflector	Light Colour	CCT (K)	Watts	Lumen (lm)	Beam Angle	Input	Class	Box	Notes
12125R/W/W	White	Black	Warm white	3000K	25W	2500lm	38°	230V	⊕	18	Complete with 650mA driver
12125R/B/W	Black	Black	Warm white	3000K	25W	2500lm	38°	230V	⊕	18	Complete with 650mA driver

Wall & Ceiling LED

65004A | 5W | COB LED | Aluminium

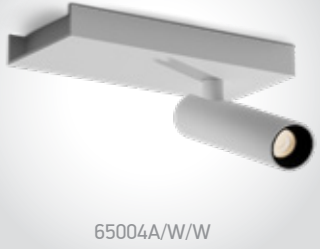

65004A/W/W

new
IP20

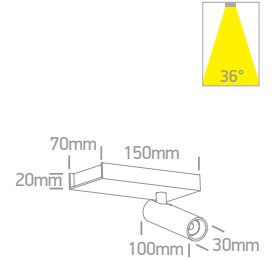
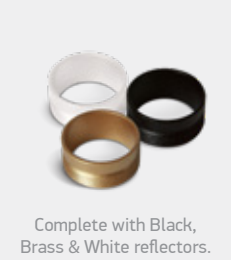

65004A | 5W | COB LED | Aluminium

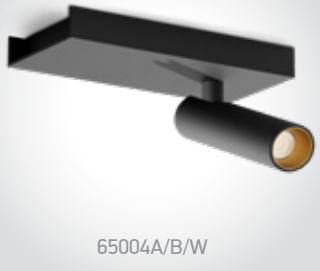

65004A/B/W

new
IP20

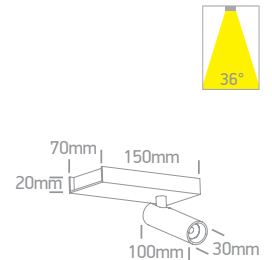
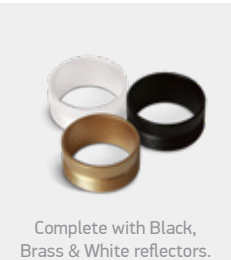

Order Code	Colour	Light Colour	CCT (K)	Watts	Lumen (lm)	Beam Angle	Input	Class	Box	Notes
65004A/W/W	White	Warm white	3000K	5W	450lm	36°	230V	⊥	30	Complete with 500mA driver
65004A/B/W	Black	Warm white	3000K	5W	450lm	36°	230V	⊥	30	Complete with 500mA driver

65004B | 2x5W | COB LED | Aluminium

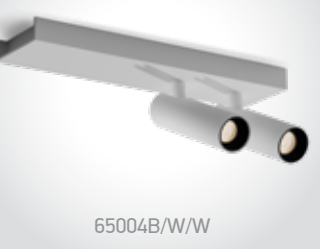

65004B/W/W

new
IP20

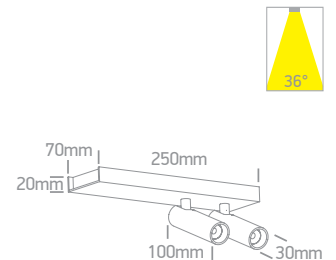
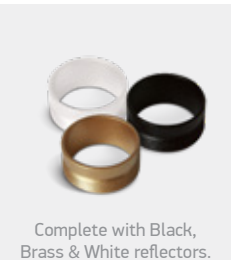

65004B | 2x5W | COB LED | Aluminium



65004B/B/W

new
IP20

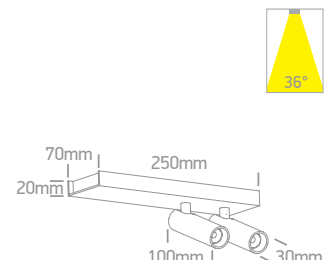
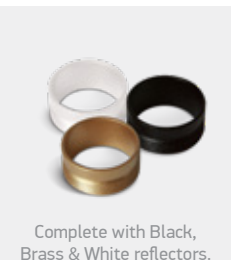

Order Code	Colour	Light Colour	CCT (K)	Watts	Lumen (lm)	Beam Angle	Input	Class	Box	Notes
65004B/W/W	White	Warm white	3000K	2x5W	900lm	36°	230V	⊥	24	Complete with 220mA driver
65004B/B/W	Black	Warm white	3000K	2x5W	900lm	36°	230V	⊥	24	Complete with 220mA driver

65004C | 3x5W | COB LED | Aluminium



65004C/W/W

new
IP20



65004C/B/W

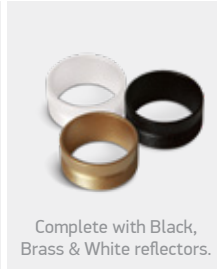

Complete with Black, Brass & White reflectors.

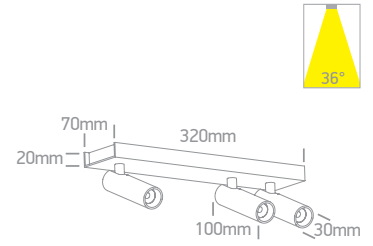

Order Code	Colour	Light Colour	CCT (K)	Watts	Lumen (lm)	Beam Angle	Input	Class	Box	Notes
65004C/W/W	White	Warm white	3000K	3x5W	1350lm	36°	230V	⊕	12	Complete with 500mA driver
65004C/B/W	Black	Warm white	3000K	3x5W	1350lm	36°	230V	⊕	12	Complete with 500mA driver

65004D | 3x5W | COB LED | Aluminium

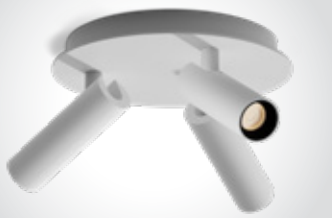

65004D/W/W

new
IP20

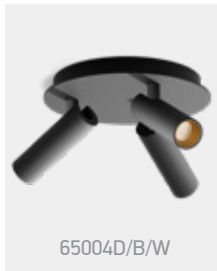
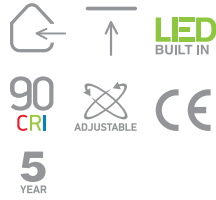

65004D/B/W

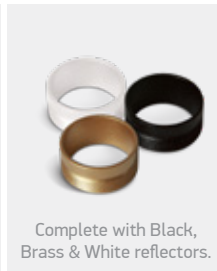

Complete with Black, Brass & White reflectors.

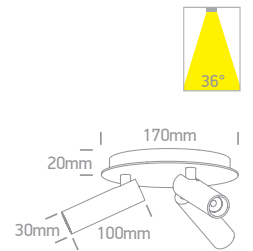

Order Code	Colour	Light Colour	CCT (K)	Watts	Lumen (lm)	Beam Angle	Input	Class	Box	Notes
65004D/W/W	White	Warm white	3000K	3x5W	1350lm	36°	230V	⊕	8	Complete with 500mA driver
65004D/B/W	Black	Warm white	3000K	3x5W	1350lm	36°	230V	⊕	8	Complete with 500mA driver

65004E | 4x5W | COB LED | Aluminium

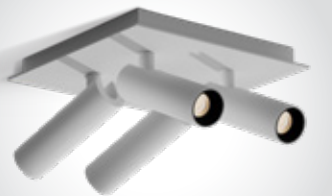

65004E/W/W

new
IP20

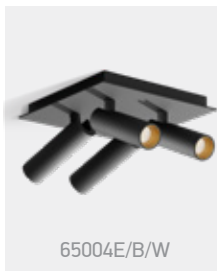
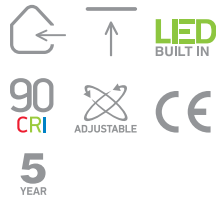

65004E/B/W

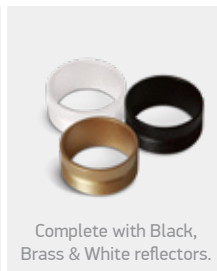

Complete with Black, Brass & White reflectors.

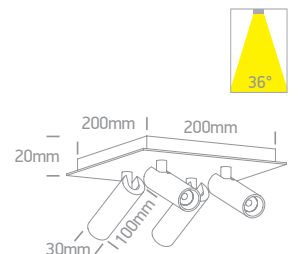

Order Code	Colour	Light Colour	CCT (K)	Watts	Lumen (lm)	Beam Angle	Input	Class	Box	Notes
65004E/W/W	White	Warm white	3000K	4x5W	1800lm	36°	230V	⊕	6	Complete with 500mA driver
65004E/B/W	Black	Warm white	3000K	4x5W	1800lm	36°	230V	⊕	6	Complete with 500mA driver

65748 | 12W | SMD LED | Solar powered | Night sensor + PIR sensor | PC + ABS

4 modes of operation.

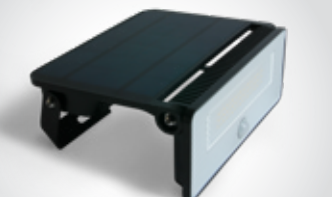

65748/B/C

new
Solar
IP54

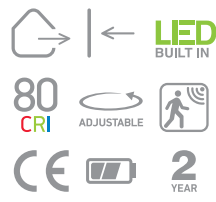

Mode 1: 100% output for 18 seconds when motion detected.
 Mode 2: Fixed 30 lumen output. 100% output for 18 seconds when motion detected.
 Mode 3: Fixed 30 lumen output.
 Mode 4: Sleep mode.

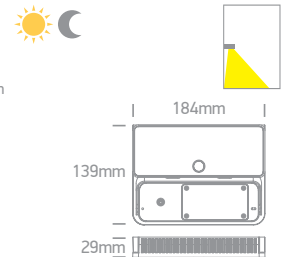

Order Code	Colour	Light Colour	CCT (K)	Watts	Lumen (lm)	Box	Notes
65748/B/C	Black	Cool white	4000K	12W	1600lm	20	2x2200mAh lithium battery

Plafo



62006/W/V

62006 | 18W | SMD LED | ABS Body

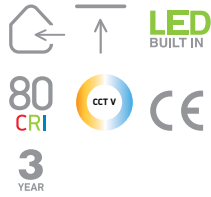

new
IP20



62006/B/V

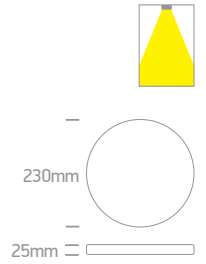

Order Code	Colour	Light Colour	CCT (K)	Watts	Lumen (lm)	Input	Class		Notes
62006/W/V	White	CCT V	2800K-3200K-4000K	18W	1440lm	230V	□	10	Complete with driver
62006/B/V	Black	CCT V	2800K-3200K-4000K	18W	1440lm	230V	□	10	Complete with driver



62006A/W/V

62006A | 24W | SMD LED | ABS Body

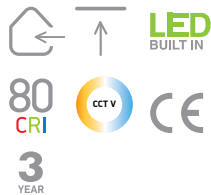

new
IP20



62006A/B/V

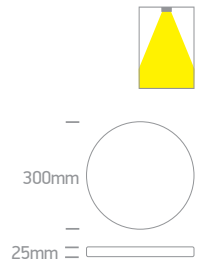

Order Code	Colour	Light Colour	CCT (K)	Watts	Lumen (lm)	Input	Class		Notes
62006A/W/V	White	CCT V	2800K-3200K-4000K	24W	1920lm	230V	□	10	Complete with driver
62006A/B/V	Black	CCT V	2800K-3200K-4000K	24W	1920lm	230V	□	10	Complete with driver



62006B/W/V

62006B | 32W | SMD LED | ABS Body

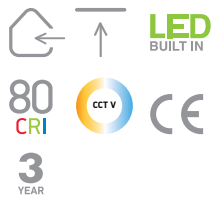

new
IP20



62006B/B/V

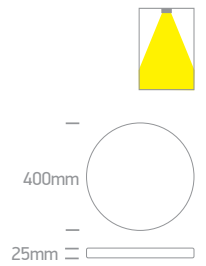

Order Code	Colour	Light Colour	CCT (K)	Watts	Lumen (lm)	Input	Class		Notes
62006B/W/V	White	CCT V	2800K-3200K-4000K	32W	2560lm	230V	□	10	Complete with driver
62006B/B/V	Black	CCT V	2800K-3200K-4000K	32W	2560lm	230V	□	10	Complete with driver



62006C/W/V

62006C | 40W | SMD LED | ABS Body

LED BUILT IN
80 CRI

3 YEAR

new
IP20

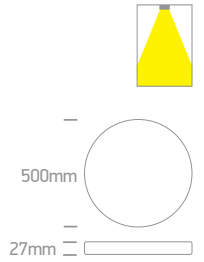

Order Code	Colour	Light Colour	CCT (K)	Watts	Lumen (lm)	Input	Class		Notes
62006C/W/V	White	CCT V	2800K-3200K-4000K	40W	3200lm	230V		8	Complete with driver



62006C/B/V

62006C | 40W | SMD LED | ABS Body

LED BUILT IN
80 CRI

3 YEAR

new
IP20

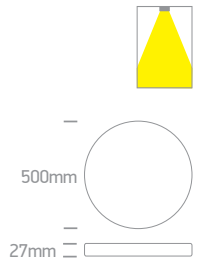

Order Code	Colour	Light Colour	CCT (K)	Watts	Lumen (lm)	Input	Class		Notes
62006C/B/V	Black	CCT V	2800K-3200K-4000K	40W	3200lm	230V		8	Complete with driver



62006D/W/V

62006D | 50W | SMD LED | ABS Body

LED BUILT IN
80 CRI

3 YEAR

new
IP20

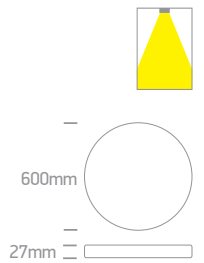

Order Code	Colour	Light Colour	CCT (K)	Watts	Lumen (lm)	Input	Class		Notes
62006D/W/V	White	CCT V	2800K-3200K-4000K	50W	4000lm	230V		4	Complete with driver



62006D/B/V

62006D | 50W | SMD LED | ABS Body

LED BUILT IN
80 CRI

3 YEAR

new
IP20

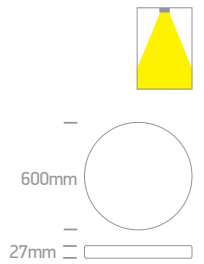

Order Code	Colour	Light Colour	CCT (K)	Watts	Lumen (lm)	Input	Class		Notes
62006D/B/V	Black	CCT V	2800K-3200K-4000K	50W	4000lm	230V		4	Complete with driver

Plafó



62134N/W/V

62134N | 30W | SMD LED | Aluminium



new
IP20

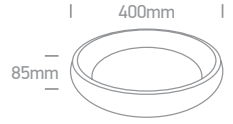

62134N/BBS/V

62134N | 30W | SMD LED | Dimmable | Aluminium

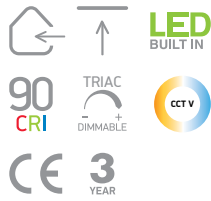

new
IP20



62134N/BGL/V

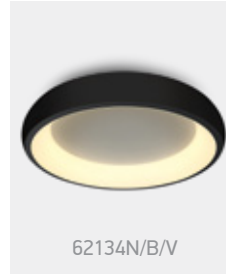

62134N/B/V

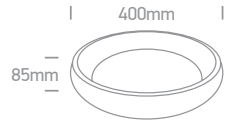

Order Code	Colour	Light Colour	CCT (K)	Watts	Lumen (lm)	Beam Angle	Input	Class	Box	Notes
62134N/W/V	White	CCT V	2700K-3000K-4000K	30W	2550lm	120°	230V	⊕	1	Complete with 700mA driver
62134N/B/V	Black	CCT V	2700K-3000K-4000K	30W	2550lm	120°	230V	⊕	1	Complete with 700mA dimmable driver
62134N/BBS/V	Brushed brass	CCT V	2700K-3000K-4000K	30W	2550lm	120°	230V	⊕	1	Complete with 700mA dimmable driver
62134N/BGL/V	Brushed gold	CCT V	2700K-3000K-4000K	30W	2550lm	120°	230V	⊕	1	Complete with 700mA dimmable driver



62142N/W/V

62142N | 42W | SMD LED | Dimmable | Aluminium

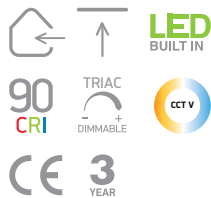

new
IP20

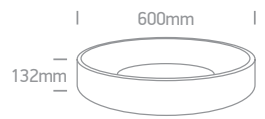

Order Code	Colour	Light Colour	CCT (K)	Watts	Lumen (lm)	Beam Angle	Input	Class	Box	Notes
62142N/W/V	White	CCT V	2700K-3000K-4000K	42W	3570lm	120°	230V	⊕	1	Complete with 1050mA dimmable driver



62132NA/W/V

62132NA | 38W | SMD LED | Dimmable | Aluminium

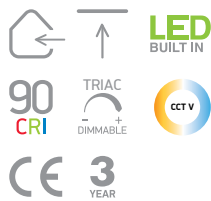

new
IP20



62132NA/B/V



Order Code	Colour	Light Colour	CCT (K)	Watts	Lumen (lm)	Beam Angle	Input	Class	Box	Notes
62132NA/W/V	White	CCT V	2700K-3000K-4000K	38W	3230lm	120°	230V	⊕	1	Complete with 1050mA dimmable driver
62132NA/B/V	Black	CCT V	2700K-3000K-4000K	38W	3230lm	120°	230V	⊕	1	Complete with 1050mA dimmable driver



62130L/W/V

62130L | 30W | SMD LED | Dimmable | Aluminium

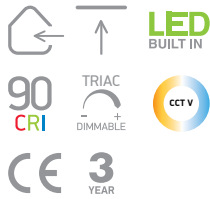

new
IP20



62130L/B/V



62130L/BBS/V

62130L | 30W | SMD LED | Dimmable | Aluminium

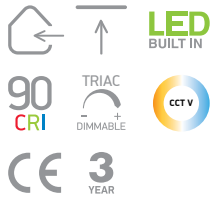

new
IP20



62130L/BGL/V

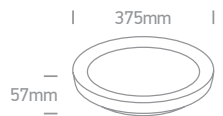

Order Code	Colour	Light Colour	CCT (K)	Watts	Lumen (lm)	Beam Angle	Input	Class	Box	Notes
62130L/W/V	White	CCT V	2700K-3000K-4000K	30W	2550lm	120°	230V	⊕	1	Complete with 700mA dimmable driver
62130L/B/V	Black	CCT V	2700K-3000K-4000K	30W	2550lm	120°	230V	⊕	1	Complete with 700mA dimmable driver
62130L/BBS/V	Brushed brass	CCT V	2700K-3000K-4000K	30W	2550lm	120°	230V	⊕	1	Complete with 700mA dimmable driver
62130L/BGL/V	Brushed gold	CCT V	2700K-3000K-4000K	30W	2550lm	120°	230V	⊕	1	Complete with 700mA dimmable driver



62148L/W/V

62148L | 48W | SMD LED | Dimmable | Aluminium

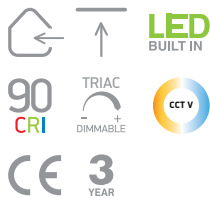

new
IP20



62148L/B/V

62148L | 48W | SMD LED | Dimmable | Aluminium

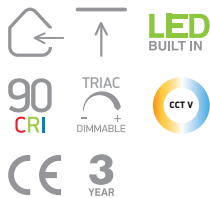

new
IP20

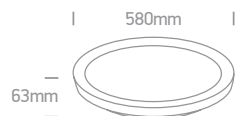

Order Code	Colour	Light Colour	CCT (K)	Watts	Lumen (lm)	Beam Angle	Input	Class	Box	Notes
62148L/W/V	White	CCT V	2700K-3000K-4000K	48W	4080lm	120°	230V	⊕	1	Complete with 1200mA dimmable driver
62148L/B/V	Black	CCT V	2700K-3000K-4000K	48W	4080lm	120°	230V	⊕	1	Complete with 1200mA dimmable driver

Plafó



67366/W/V

67366 | 12W | SMD LED | PC

Emergency version 67366E/W/V.

new
IP54

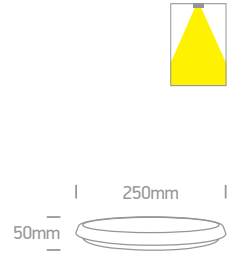

Order Code	Colour	Light Colour	CCT (K)	Watts	Lumen (lm)	Input	Class		Notes
67366/W/V	White	CCT V	3000K-4000K-5000K	12W	1000lm	230V		20	Complete with 160mA driver



67368/W/V

67368 | 18W | SMD LED | PC

new
IP54

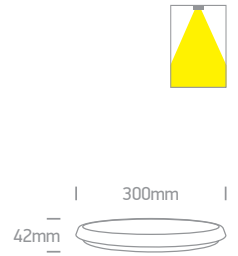

Order Code	Colour	Light Colour	CCT (K)	Watts	Lumen (lm)	Input	Class		Notes
67368/W/V	White	CCT V	3000K-4000K-5000K	18W	1500lm	230V		10	Complete with 250mA driver



67370/W/V

67370 | 25W | SMD LED | PC

new
IP54

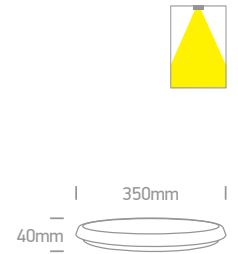

Order Code	Colour	Light Colour	CCT (K)	Watts	Lumen (lm)	Input	Class		Notes
67370/W/V	White	CCT V	3000K-4000K-5000K	25W	2000lm	230V		10	Complete with 300mA driver

67220A | 26W | SMD LED | PC



67220A/W/V

new
IP65

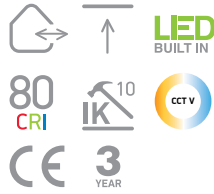

67220A/B/V

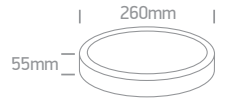

Order Code	Colour	Light Colour	CCT (K)	Watts	Lumen (lm)	Input	Class		Notes
67220A/W/V	White	CCT V	3000K-4000K-6000K	26W	2750lm	230V		5	Complete with 145mA driver
67220A/B/V	Black	CCT V	3000K-4000K-6000K	26W	2750lm	230V		5	Complete with 145mA driver

67220B | 35W | SMD LED | PC



67220B/W/V

new
IP65

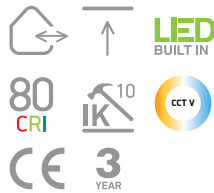

67220B/B/V

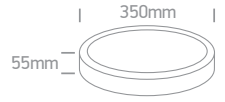

Order Code	Colour	Light Colour	CCT (K)	Watts	Lumen (lm)	Input	Class		Notes
67220B/W/V	White	CCT V	3000K-4000K-6000K	35W	3675lm	230V		5	Complete with 145mA driver
67220B/B/V	Black	CCT V	3000K-4000K-6000K	35W	3675lm	230V		5	Complete with 145mA driver

67220E | 35W | SMD LED | PC

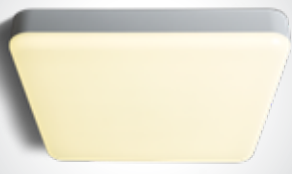

67220E/W/V

new
IP65

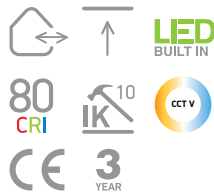

Order Code	Colour	Light Colour	CCT (K)	Watts	Lumen (lm)	Input	Class		Notes
67220E/W/V	White	CCT V	3000K-4000K-6000K	35W	3675lm	230V		5	Complete with 140mA driver

67498 | 20W | SMD LED | ABS + PC



67498/W/V

new
IP65

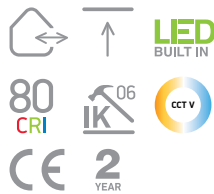

Order Code	Colour	Light Colour	CCT (K)	Watts	Lumen (lm)	Input	Class		Notes
67498/W/V	White	CCT V	3000K-4000K-6500K	20W	1300lm	230V		10	Complete with 500mA driver.

Pendants



63146A | 5x7W | MR16 | GU10 | Aluminium

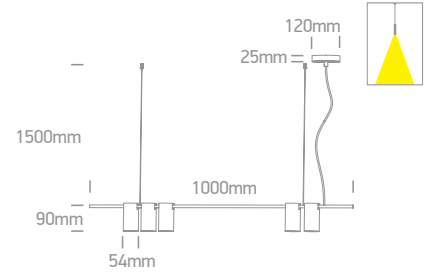

new
IP20



63146A | 5x7W | MR16 | GU10 | Aluminium

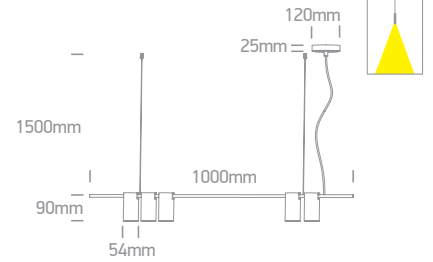

new
IP20

Order Code	Colour	Watts	Input	Class		Notes
63146A/B	Black	5x7W	100-240V		1	-
63146A/BBS	Brushed Brass	5x7W	100-240V		1	-



63146B | 7x7W | MR16 | GU10 | Aluminium

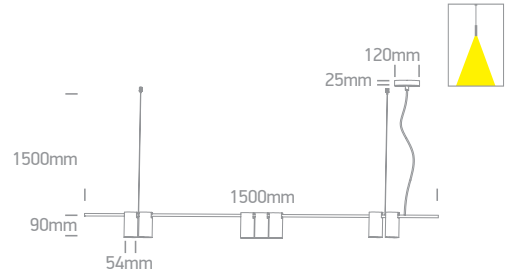

new
IP20



63146B | 7x7W | MR16 | GU10 | Aluminium

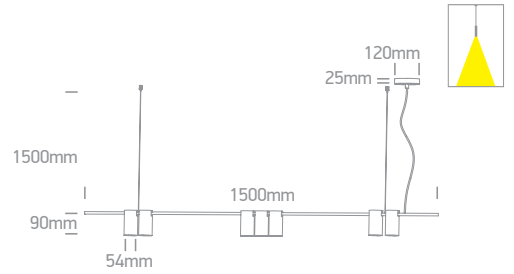

new
IP20

Order Code	Colour	Watts	Input	Class		Notes
63146B/B	Black	7x7W	100-240V		1	-
63146B/BBS	Brushed Brass	7x7W	100-240V		1	-



63146C | 10x7W | MR16 | GU10 | Aluminium



new

IP20

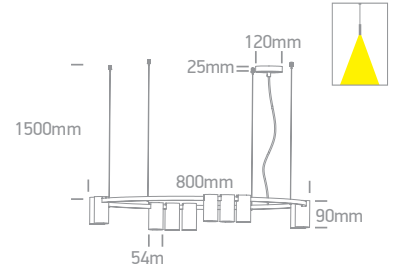

63146C | 10x7W | MR16 | GU10 | Aluminium



new

IP20

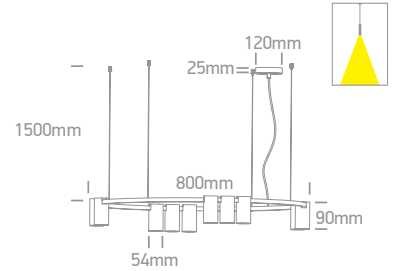

Order Code	Colour	Watts	Input	Class		Notes
63146C/B	Black	10x7W	100-240V		1	-
63146C/BBS	Brushed Brass	10x7W	100-240V		1	-



63146D | 15x7W | MR16 | GU10 | Aluminium



new

IP20

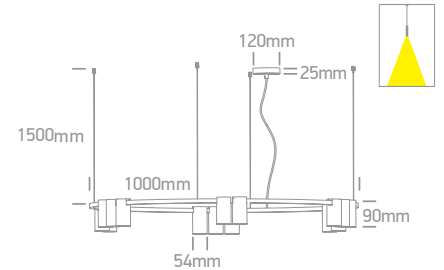

63146D | 15x7W | MR16 | GU10 | Aluminium



new

IP20

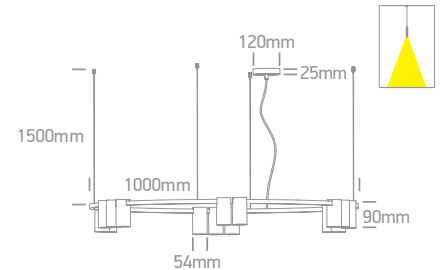

Order Code	Colour	Watts	Input	Class		Notes
63146D/B	Black	15x7W	100-240V		1	-
63146D/BBS	Brushed Brass	15x7W	100-240V		1	-

Decorative



63152A/B/W

63152A | 20W | SMD LED | Dimmable | Aluminium

LED BUILT IN
 80 CRI
 TRIAC DIMMABLE
 3 YEAR
 CE

new
IP20

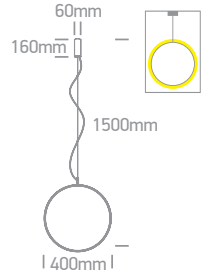

Order Code	Colour	Light Colour	CCT (K)	Watts	Lumen (lm)	Input	Class		Notes
63152A/B/W	Black	Warm white	3000K	20W	1400lm	230V		1	Complete with 500mA dimmable driver



63152B/B/W

63152B | 30W | SMD LED | Dimmable | Aluminium

LED BUILT IN
 80 CRI
 TRIAC DIMMABLE
 3 YEAR
 CE

new
IP20

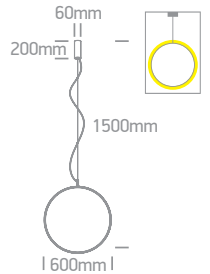

Order Code	Colour	Light Colour	CCT (K)	Watts	Lumen (lm)	Input	Class		Notes
63152B/B/W	Black	Warm white	3000K	30W	2100lm	230V		1	Complete with 700mA dimmable driver



63152C/B/W

63152C | 40W | SMD LED | Dimmable | Aluminium

LED BUILT IN
 80 CRI
 TRIAC DIMMABLE
 3 YEAR
 CE

new
IP20

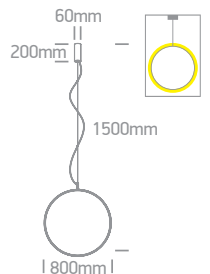

Order Code	Colour	Light Colour	CCT (K)	Watts	Lumen (lm)	Input	Class		Notes
63152C/B/W	Black	Warm white	3000K	40W	2800lm	230V		1	Complete with 1050mA dimmable driver



63150 | 48W | SMD LED | Dimmable | Aluminium

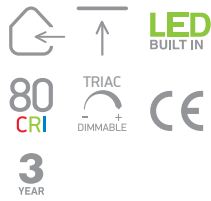

new
IP20

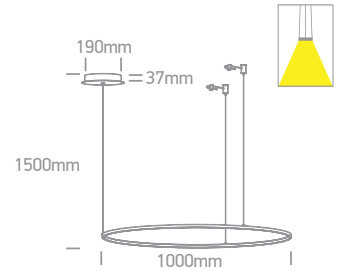

Order Code	Colour	Light Colour	CCT (K)	Watts	Lumen (lm)	Input	Class	Box	Notes
63150/B/W	Black	Warm white	3000K	48W	3550lm	230V	⊕	1	Complete with 1200mA dimmable driver



63150A | 65W | SMD LED | Dimmable | Aluminium



new
IP20

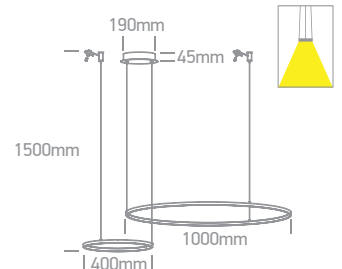

Order Code	Colour	Light Colour	CCT (K)	Watts	Lumen (lm)	Input	Class	Box	Notes
63150A/B/W	Black	Warm white	3000K	65W	4800lm	230V	⊕	1	Complete with 2x700mA dimmable drivers



63150B | 65W | SMD LED | Dimmable | Aluminium



new
IP20

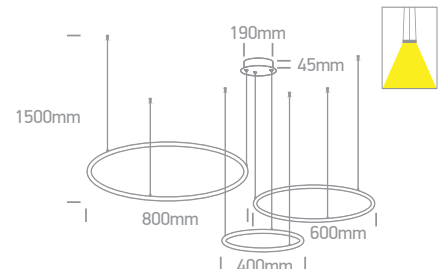

Order Code	Colour	Light Colour	CCT (K)	Watts	Lumen (lm)	Input	Class	Box	Notes
63150B/B/W	Black	Warm white	3000K	65W	4800lm	230V	⊕	1	Complete with 2x700mA dimmable drivers



63150C | 100W | SMD LED | Dimmable | Aluminium



new
IP20

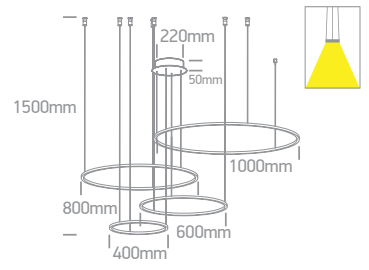

Order Code	Colour	Light Colour	CCT (K)	Watts	Lumen (lm)	Input	Class	Box	Notes
63150C/B/W	Black	Warm white	3000K	100W	7400lm	230V	⊕	1	Complete with 2x1200mA dimmable drivers

Decorative

63154A | 40W | SMD LED | Dimmable | Aluminium



63154A/B/W

new
IP20

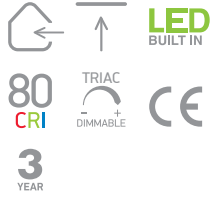

63154A/CH/W

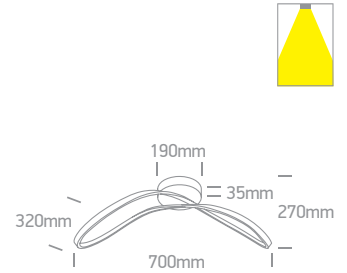

Order Code	Colour	Light Colour	CCT (K)	Watts	Lumen (lm)	Input	Class	Box	Notes
63154A/B/W	Black	Warm white	3000K	40W	2800lm	230V	⊕	1	Complete with 1050mA dimmable driver
63154A/CH/W	Champagne	Warm white	3000K	40W	2800lm	230V	⊕	1	Complete with 1050mA dimmable driver

63154B | 20W | SMD LED | Dimmable | Aluminium



63154B/B/W

new
IP20

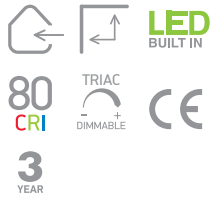

63154B/CH/W

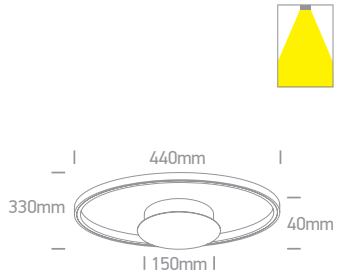

Order Code	Colour	Light Colour	CCT (K)	Watts	Lumen (lm)	Input	Class	Box	Notes
63154B/B/W	Black	Warm white	3000K	20W	1400lm	230V	⊕	1	Complete with 500mA dimmable driver
63154B/CH/W	Champagne	Warm white	3000K	20W	1400lm	230V	⊕	1	Complete with 500mA dimmable driver

63154C | 40W | SMD LED | Dimmable | Aluminium



63154C/B/W

new
IP20

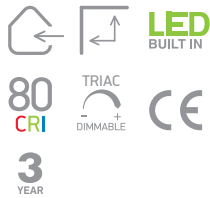

63154C/CH/W

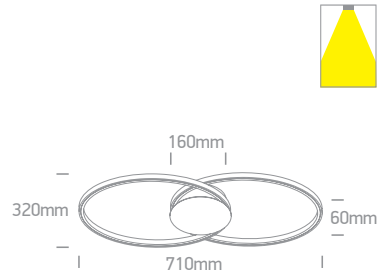

Order Code	Colour	Light Colour	CCT (K)	Watts	Lumen (lm)	Input	Class	Box	Notes
63154C/B/W	Black	Warm white	3000K	40W	2800lm	230V	⊕	1	Complete with 1050mA dimmable driver
63154C/CH/W	Champagne	Warm white	3000K	40W	2800lm	230V	⊕	1	Complete with 1050mA dimmable driver

63154D | 60W | SMD LED | Dimmable | Aluminium



63154D/B/W

new
IP20



63154D/CH/W

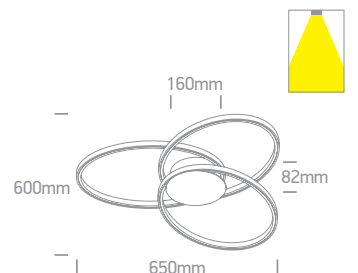

Order Code	Colour	Light Colour	CCT (K)	Watts	Lumen (lm)	Input	Class	Box	Notes
63154D/B/W	Black	Warm white	3000K	60W	4200lm	230V	⊕	1	Complete with 2x700mA dimmable drivers
63154D/CH/W	Champagne	Warm white	3000K	60W	4200lm	230V	⊕	1	Complete with 2x700mA dimmable drivers



65148A | 12W | SMD LED | Aluminium



new
IP20

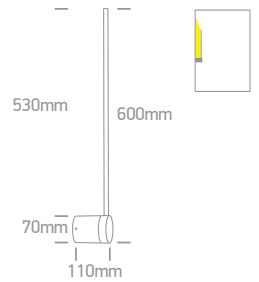
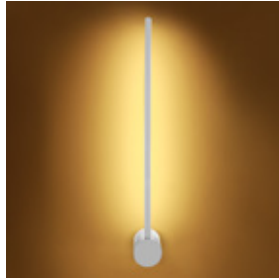

65148A | 12W | SMD LED | Aluminium

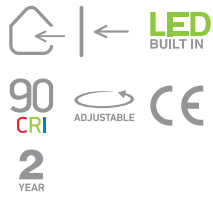

new
IP20

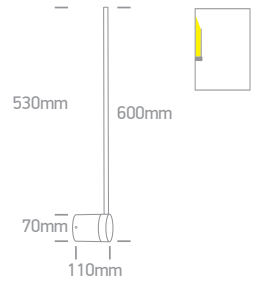
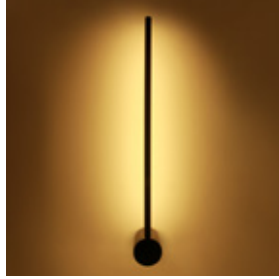

Order Code	Colour	Light Colour	CCT (K)	Watts	Lumen (lm)	Input	Class	Box	Notes
65148A/W/W	White	Warm white	3000K	12W	950lm	230V	⊕	12	Complete with 280mA driver
65148A/B/W	Black	Warm white	3000K	12W	950lm	230V	⊕	12	Complete with 280mA driver



65148B | 15W | SMD LED | Aluminium



new
IP20

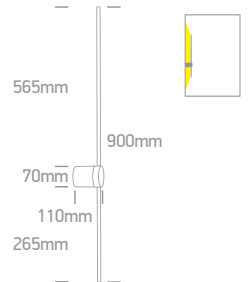
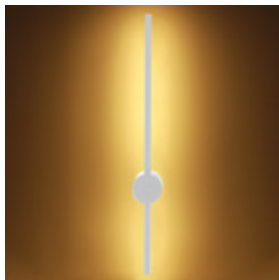

65148B | 15W | SMD LED | Aluminium

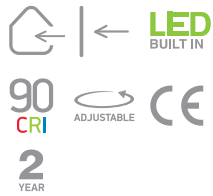

new
IP20

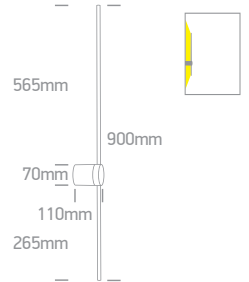
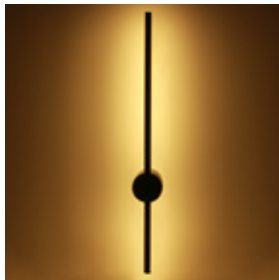

Order Code	Colour	Light Colour	CCT (K)	Watts	Lumen (lm)	Input	Class	Box	Notes
65148B/W/W	White	Warm white	3000K	15W	1200lm	230V	⊕	12	Complete with 350mA driver
65148B/B/W	Black	Warm white	3000K	15W	1200lm	230V	⊕	12	Complete with 350mA driver

Decorative



63076A/B/W

63076A | 5W | COB LED | Aluminium



new
IP20

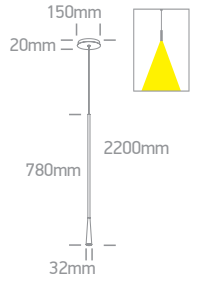

Order Code	Colour	Light Colour	CCT (K)	Watts	Lumen (lm)	Input	Class	Box	Notes
63076A/B/W	Black	Warm white	3000K	5W	300lm	230V	⊕	6	Complete with 500mA driver

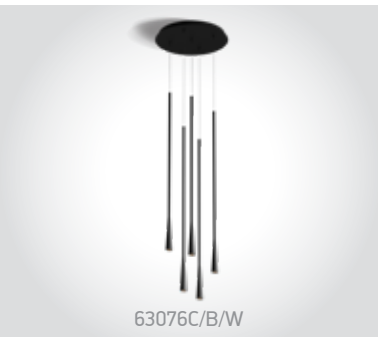

63076C/B/W

63076C | 5x5W | COB LED | Aluminium



new
IP20

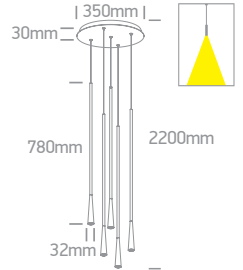

Order Code	Colour	Light Colour	CCT (K)	Watts	Lumen (lm)	Input	Class	Box	Notes
63076C/B/W	Black	Warm white	3000K	5x5W	1500lm	230V	⊕	1	Complete with 2x500mA drivers

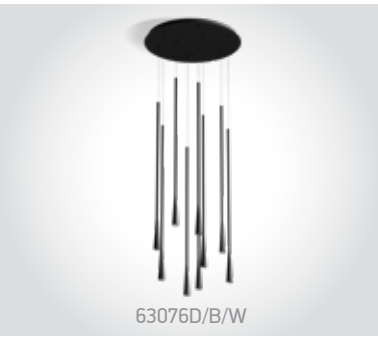

63076D/B/W

63076D | 9x5W | COB LED | Aluminium



new
IP20

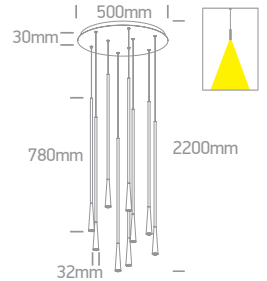

Order Code	Colour	Light Colour	CCT (K)	Watts	Lumen (lm)	Input	Class	Box	Notes
63076D/B/W	Black	Warm white	3000K	9x5W	2700lm	230V	⊕	1	Complete with 3x500mA drivers



63076E/B/W

63076E | 5x5W | COB LED | Aluminium



new
IP20

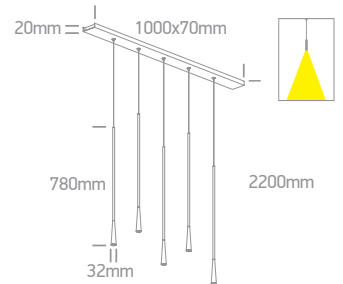

Order Code	Colour	Light Colour	CCT (K)	Watts	Lumen (lm)	Input	Class	Box	Notes
63076E/B/W	Black	Warm white	3000K	5x5W	1500lm	230V	⊕	1	Complete with 5x500mA drivers

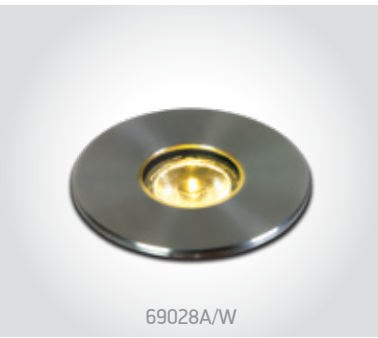

69028A/W

69028A | 2W | LED | Stainless Steel 316

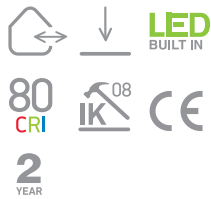

new
IP67

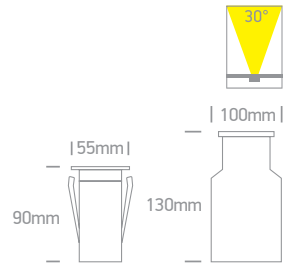

Order Code	Colour	Light Colour	CCT (K)	Watts	Lumen (lm)	Beam Angle	Input	Class					Notes
69028A/W	Stainless steel	Warm white	3000K	2W	90lm	30°	230V		200cm	100mm	130mm+300mm drainage	12	AC LED

Garden & Underwater



67508A/AN/C

67508A | 8W | SMD LED | Die cast

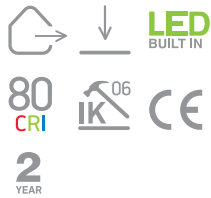

new
IP65



67508A/AN/W

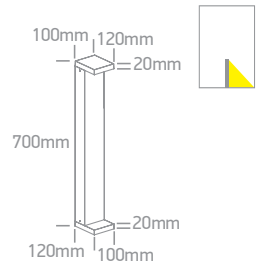

Order Code	Colour	Light Colour	CCT (K)	Watts	Lumen (lm)	Input	Class		Notes
67508A/AN/C	Anthracite	Cool white	4000K	8W	600lm	230V		2	Complete with 500mA driver
67508A/AN/W	Anthracite	Warm white	3000K	8W	600lm	230V		2	Complete with 500mA driver



67508B/AN/C

67508B | 8W | SMD LED | LED Bollard 2xSchuko Sockets 1000W each | Die cast

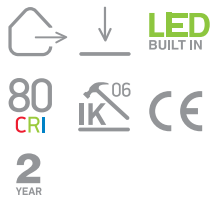

new
IP65



67508B/AN/W

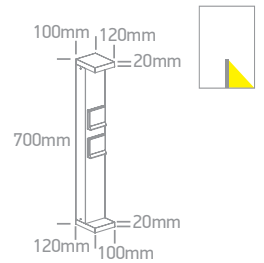

Order Code	Colour	Light Colour	CCT (K)	Watts	Lumen (lm)	Input	Class		Notes
67508B/AN/C	Anthracite	Cool white	4000K	8W	600lm	230V		2	Complete with 500mA driver
67508B/AN/W	Anthracite	Warm white	3000K	8W	600lm	230V		2	Complete with 500mA driver



38115LB | 15W | SMD LED | PC

LED BUILT IN
 80 CRI
 IK08
 CCT V
 CE
 2 YEAR
 new
 IP66

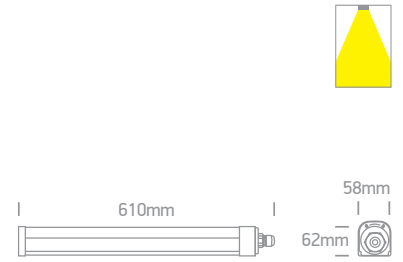
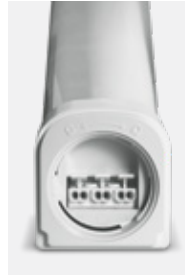
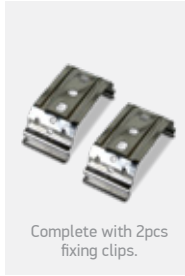

38130LB | 30W | SMD LED | PC

LED BUILT IN
 80 CRI
 IK08
 CCT V
 CE
 2 YEAR
 new
 IP66

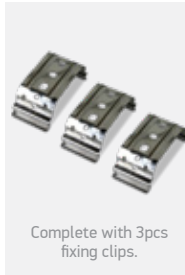

38150LB | 50W | SMD LED | PC

LED BUILT IN
 80 CRI
 IK08
 CCT V
 CE
 2 YEAR
 new
 IP66

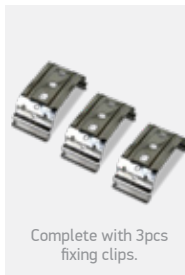

Order Code	Colour	Light Colour	CCT (K)	Watts	Lumen (lm)	Input	Class		Notes
38115LB/V	White	CCT V	3000K-4000K-6000K	15W	1725lm	230V		15	Complete with 140mA driver
38130LB/V	White	CCT V	3000K-4000K-6000K	30W	3450lm	230V		12	Complete with 230mA driver
38150LB/V	White	CCT V	3000K-4000K-6000K	50W	5750lm	230V		9	Complete with 300mA driver



70112 | 75W PV | LED | Die cast

LED BUILT IN
 80 CRI
 IK08
 CCT V
 PV
 CE
 5 YEAR
 new
 IP66

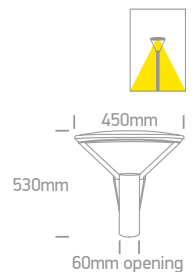
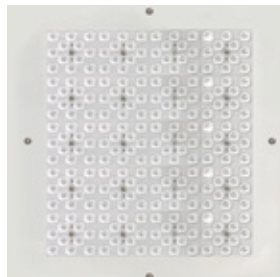

Order Code	Colour	Light Colour	CCT (K)	Watts	Lumen (lm)	Input	Class			Notes
70112/B/V	Black	CCT V	2700K-3300K-4000K	25W-40W-60W-75W	8250lm (75W)	120-240V		150cm	1	Complete with 1730mA driver

89001/EME | 1-30W | Built-in Emergency kit for LED fittings | Emergency 3Hrs Maintained

Use inside fittings/Self-test.



new
IP20

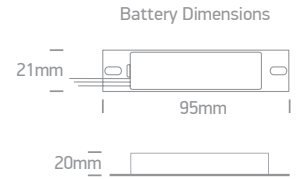
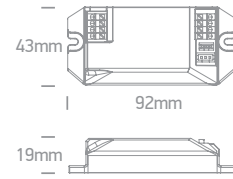

WIRING DIAGRAM

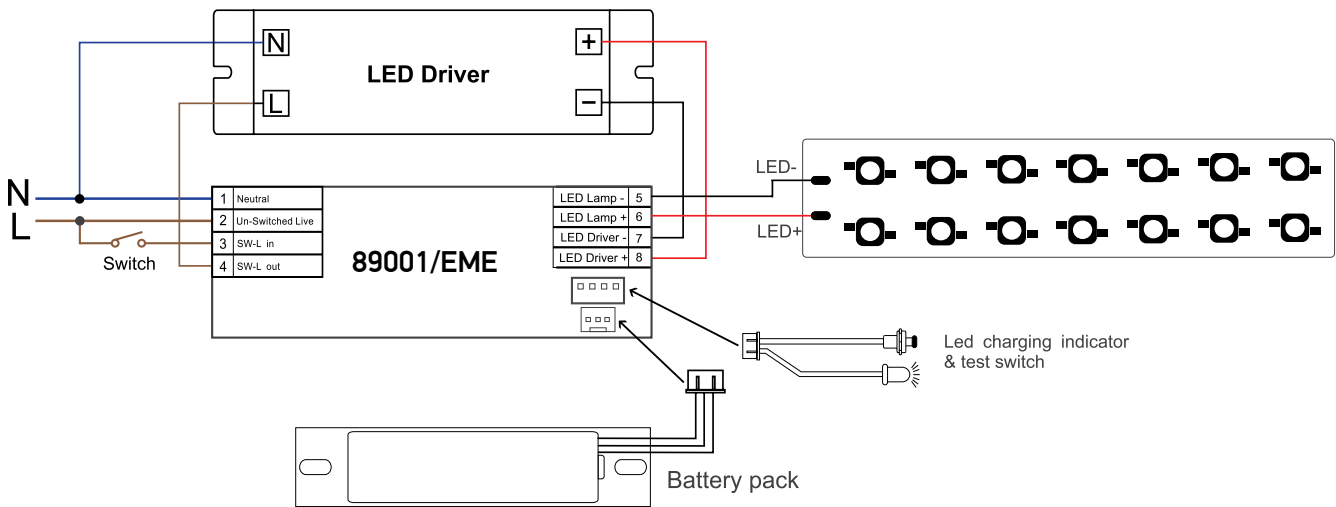

This kit will only operate with LED Fittings/Strips 1-30W suitable for 9-45V DC power supply. The driver automatically adjusts the output LED current to provide the optimum match between the battery and the load, providing maximum illumination whilst ensuring full battery duration.

Emergency mode light output compared with normal operation:

Luminaire Power	5W	10W	15W	20W	25W	30W
	20%	10%	7%	5%	4%	3%

Order Code	Input	Watts	Class	Battery Type	Charge Period	Battery Duration		Notes
89001/EME	230V	1-30W		LiFePO4 3,2V 1,6Ah	24Hrs	3Hrs	50	Supplied with battery

Emergency Lights



89005B/EME | 5-50W | Emergency kit for LED Downlights and LED strips | Emergency 3Hrs Maintained | Self-test.

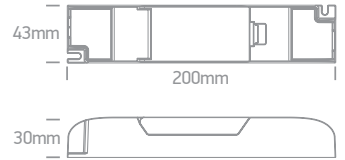

new
IP20

WIRING DIAGRAM

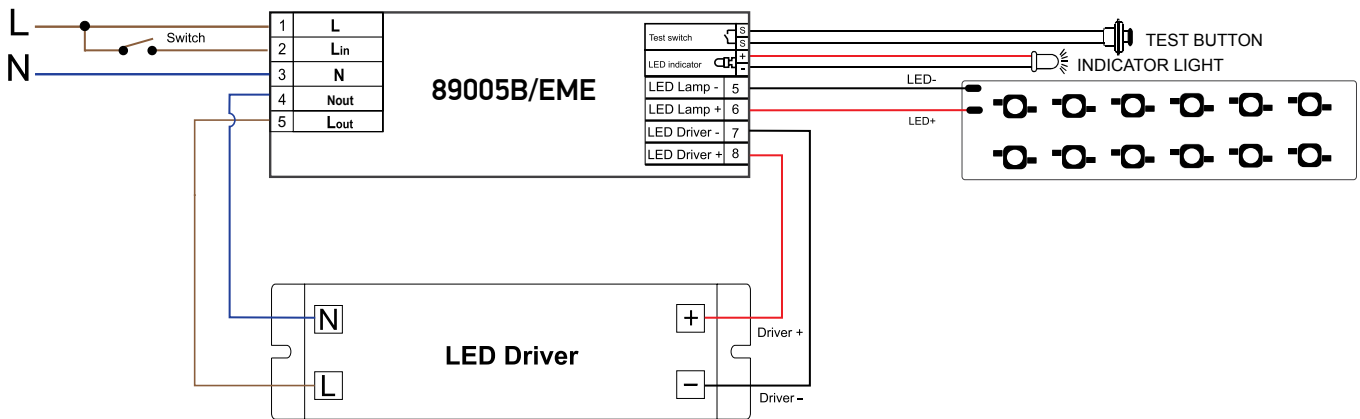

This kit will only operate with LED Fittings/Strips 5-50W suitable for 8-60V DC power supply. The driver automatically adjusts the output LED current to provide the optimum match between the battery and the load, providing maximum illumination whilst ensuring full battery duration.

Emergency mode light output compared with normal operation:

Luminaire Power	5W	7W	10W	12W	15W	20W	25W	30W	35W	40W	45W	50W
	50%	35%	25%	20%	17%	12%	10%	8%	7%	6%	6%	5%

Order Code	Input	Watts	Class	Battery Type	Charge Period	Battery Duration		Notes
89005B/EME	230V	5-50W		LiFePO4 3,2V 3,2Ah	24Hrs	3Hrs	25	Supplied with battery

TRIAC Dimmable Mini Series

Constant current



89007T | 3,5-7W | 350mA | TRIAC | Dimmable



new

IP20



Order Code	Input	Power	Output	Class	Dimmable		Notes
89007T	230V	3,5-7,7W	350mA		YES	100	Use TRIAC dimmer



89010AT | 5-10W | 700mA | TRIAC | Dimmable



new

IP20



Order Code	Input	Power	Output	Class	Dimmable		Notes
89010AT	230V	4,9-10,5W	700mA		YES	100	Use TRIAC dimmer

The TRIAC Dimmable Range

100-350mA Constant current



89009UT | TRIAC | Dimmable

Adjustable output using DIP switch.



new

IP20





Output Current	100mA	150mA	200mA	250mA	300mA	350mA
Output Power	0,9-4,2W	1,35-6,3W	1,8-8,4W	2,25-8,25W	2,7-8,1W	3,15-8,4W

Order Code	Input	Power	Output	Class	Dimmable		Notes
89009UT	230V	Refer to table	Adjustable		YES	126	Use TRIAC dimmer

Drivers

Adjustable Constant Current DALI Dimmable

DALI & Push to DIM

new
IP20

89007AL | DALI & Push to DIM | Dimmable

Adjustable output using DIP switches.



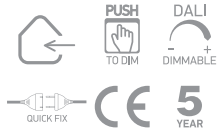



LED Current Selection

350mA	<input type="radio"/>	<input type="radio"/>	<input type="radio"/>
400mA	<input checked="" type="radio"/>	<input type="radio"/>	<input type="radio"/>
450mA	<input type="radio"/>	<input checked="" type="radio"/>	<input type="radio"/>
500mA	<input checked="" type="radio"/>	<input checked="" type="radio"/>	<input type="radio"/>
550mA	<input type="radio"/>	<input type="radio"/>	<input checked="" type="radio"/>
600mA	<input checked="" type="radio"/>	<input type="radio"/>	<input checked="" type="radio"/>
650mA	<input type="radio"/>	<input checked="" type="radio"/>	<input checked="" type="radio"/>
700mA	<input checked="" type="radio"/>	<input checked="" type="radio"/>	<input checked="" type="radio"/>
	1	2	3



Output Current	350mA	400mA	450mA	500mA	550mA	600mA	650mA	700mA
Output Power	1,75-7W	2-8W	2,25-7,65W	2,5-8W	2,75-7,7W	3-7,8W	3,25-7,8W	3,5-7,7W

Order Code	Input	Power	Output	Class	Dimmable		Notes
89007AL	230V	Refer to table	Adjustable		YES	50	DALI & Push to DIM

new
IP20

89015L | DALI & Push to DIM | Dimmable

Adjustable output using DIP switches.



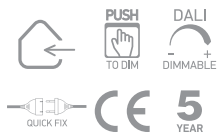



LED Current Selection

120mA	<input type="radio"/>	<input type="radio"/>	<input type="radio"/>
150mA	<input checked="" type="radio"/>	<input type="radio"/>	<input type="radio"/>
180mA	<input type="radio"/>	<input checked="" type="radio"/>	<input type="radio"/>
210mA	<input checked="" type="radio"/>	<input type="radio"/>	<input type="radio"/>
250mA	<input type="radio"/>	<input type="radio"/>	<input checked="" type="radio"/>
280mA	<input checked="" type="radio"/>	<input type="radio"/>	<input checked="" type="radio"/>
320mA	<input type="radio"/>	<input checked="" type="radio"/>	<input checked="" type="radio"/>
350mA	<input checked="" type="radio"/>	<input checked="" type="radio"/>	<input checked="" type="radio"/>
	1	2	3



Output Current	120mA	150mA	180mA	210mA	250mA	280mA	320mA	350mA
Output Power	1,08-5,76W	1,35-7,20W	1,62-8,64W	1,89-10W	2,25-12W	2,52-13,44W	2,88-15W	3,15-14,7W

Order Code	Input	Power	Output	Class	Dimmable		Notes
89015L	230V	Refer to table	Adjustable		YES	50	DALI & Push to DIM

new
IP20

89015AL | DALI & Push to DIM | Dimmable

Adjustable output using DIP switches.



LED Current Selection

350mA	<input type="radio"/>	<input type="radio"/>	<input type="radio"/>
400mA	<input checked="" type="radio"/>	<input type="radio"/>	<input type="radio"/>
450mA	<input type="radio"/>	<input checked="" type="radio"/>	<input type="radio"/>
500mA	<input checked="" type="radio"/>	<input checked="" type="radio"/>	<input type="radio"/>
550mA	<input type="radio"/>	<input type="radio"/>	<input checked="" type="radio"/>
600mA	<input checked="" type="radio"/>	<input type="radio"/>	<input checked="" type="radio"/>
650mA	<input type="radio"/>	<input checked="" type="radio"/>	<input checked="" type="radio"/>
700mA	<input checked="" type="radio"/>	<input checked="" type="radio"/>	<input checked="" type="radio"/>
	1	2	3



Output Current	350mA	400mA	450mA	500mA	550mA	600mA	650mA	700mA
Output Power	3,15-14,7W	3,6-14,8W	4,05-14,85W	4,5-15W	4,95-14,85W	5,4-15W	5,85-14,95W	6,3-14,7W

Order Code	Input	Power	Output	Class	Dimmable		Notes
89015AL	230V	Refer to table	Adjustable		YES	50	DALI & Push to DIM

Adjustable Constant Current DALI Dimmable DALI & Push to DIM



89026AL | DALI & Push to DIM | Dimmable

Adjustable output using DIP switches.

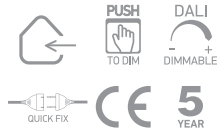

LED Current Selection				
160mA	●	●	○	○
200mA	○	○	○	○
250mA	○	○	○	○
300mA	○	○	○	○
350mA	○	○	○	○
400mA	○	○	○	○
450mA	○	○	○	○
500mA	○	○	○	○
550mA	○	○	○	○
600mA	○	○	○	○
650mA	○	○	○	○
700mA	○	○	○	○
	1	2	3	4



new
IP20

Output Current	160mA	200mA	250mA	300mA	350mA	400mA	450mA	500mA	550mA	600mA	650mA	700mA
Output Power	4,80-8W	6-10W	5-12,50W	6-15W	7-17,50W	8-20W	9-22,50W	10-25W	11-25,85W	12-25,80W	13-26W	14-26W

Order Code	Input	Power	Output	Class	Dimmable		Notes
89026AL	230V	Refer to table	Adjustable		YES		DALI & Push to DIM



89044L | DALI & Push to DIM | Dimmable

Adjustable output using DIP switches.

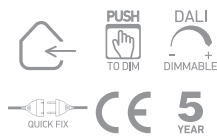

LED Current Selection		
700mA	○	○
750mA	○	○
800mA	○	○
850mA	○	○
900mA	○	○
950mA	○	○
1000mA	○	○
1050mA	○	○
	1	2



new
IP20

Output Current	700mA	750mA	800mA	850mA	900mA	950mA	1000mA	1050mA
Output Power	14-35W	15-37,50W	16-40W	17-42,50W	18-43W	19-43,70W	20-40W	21-40W

Order Code	Input	Power	Output	Class	Dimmable		Notes
89044L	230V	Refer to table	Adjustable		YES		DALI & Push to DIM

Drivers

The 24V DC TRIAC Dimmable Range

Constant voltage



89050VT | 12-50W | 24V DC | TRIAC | Dimmable



new
IP20



Order Code	Input	Power	Output	Class	Dimmable		Notes
89050VT	230V	12-50W	24V DC		YES	20	Use TRIAC dimmer



89150VT | 20-150W | 24V DC | TRIAC | Dimmable



new
IP20



Order Code	Input	Power	Output	Class	Dimmable		Notes
89150VT	230V	20-150W	24V DC		YES	15	Use TRIAC dimmer



89200VT | 75-200W | 24V DC | TRIAC | Dimmable



new
IP20

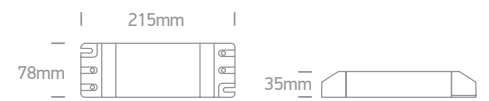

Order Code	Input	Power	Output	Class	Dimmable		Notes
89200VT	230V	75-200W	24V DC		YES	15	Use TRIAC dimmer

The 24V DC Slim Range Constant voltage



89240VL | 240W | 24V DC



new
IP20



Order Code	Input	Power	Output	Class	Dimmable		Notes
89240VL	230V	240W	24V DC		NO	50	-

The 24V DC Slim Dimmable Constant voltage



89150VLT | 30-150W | 24V DC | TRIAC | Dimmable



new
IP20



Order Code	Input	Power	Output	Class	Dimmable		Notes
89150VLT	230V	30-150W	24V DC		YES	20	Use TRIAC dimmer

The 48V DC Slim Range Constant voltage



89240XL | 240W | 48V DC



new
IP20

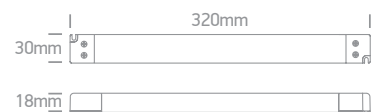

Order Code	Input	Power	Output	Class	Dimmable		Notes
89240XL	230V	240W	48V DC		NO	50	-

Drivers

The 24V DC Waterproof IP67 Range

DALI & Push to DIM



89150VPL | 15-150W | 24V DC | DALI & Push to DIM | Dimmable

new
IP67

CE 5 YEAR

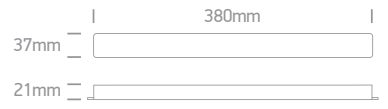

Order Code	Input	Power	Output	Class	S	Dimmable		Notes
89150VPL	230V	15-150W	24V DC		100cm	YES	10	-



89240VPL | 24-240W | 24V DC | DALI & Push to DIM | Dimmable

new
IP67

CE 5 YEAR

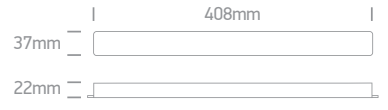

Order Code	Input	Power	Output	Class	S	Dimmable		Notes
89240VPL	230V	24-240W	24V DC		100cm	YES	10	-



060052 | ONE LIGHT Catalogue 2025 | Edition 1



new